



F0001527



F0001525



F0001524



F0001531



F0001542



F0000015



F0001543



F0000921



F0000906



F0000918



F0000913

**Welder Inverters, Air Cooled, Arc**

Stock Code	System Code	Product	Output/Input	Duty Cycle	Weight	UOM	Warranty	Brand
WD6030	F0001526	Pro Single Board IGBT/MMA, Hot Start	150A, 220V	25% @ 150A	4.1Kg	EA	1 Yr	Octo
WD6051	F0001531	Pro Single Board IGBT/MMA, Hot Start	160A, 220V	35% @ 150A	8Kg	EA	1 Yr	Octo
WD6040	F0001527	Industrial IGBT/MMA, Hot Start, VRD	180A, 220V	30% @ 180A	4.7Kg	EA	2 Yrs	Jasic
F0001525	F0001525	Industrial IGBT/MMA, Adaptive Arc Force, Hot Start, Generator Friendly	200A, 220V	60% @ 200A	4.1Kg	EA	3 Yrs	Octo Weld
F0002867	F0002867	Industrial IGBT/MMA, Adaptive Arc Force, Hot Start, Generator Friendly	200A, 220V	60% @ 200A	4.1Kg	EA	3 Yrs	Jasic
WD6080	F0001541	Industrial IGBT/MMA, Arc Force, Hot Start, VRD	200A, 220V	40% @ 200A	8.9 Kg	EA	2 Yrs	Jasic
WD6020	F0001524	Industrial IGBT/MMA/TIG, Arc Force, Hot Start, VRD	200A, 220V	100% @ 200A	9.6 Kg	EA	3 Yrs	Jasic
WD6081	F0001542	Industrial IGBT/MMA, Arc Force, Hot Start, VRD	225A, 380V	60% @ 225A	17.2 Kg	EA	3 Yr	Jasic
WD6082	F0001543	Industrial IGBT/MMA, Arc Force, Hot Start, VRD	400A, 380V	60% @ 400A	25 Kg	EA	3 Yrs	Jasic
F0000015	F0000015	Industrial IGBT/MMA/Gouging, Arc Force, Hot Start	630A, 380V	60% @ 630A	55 Kg	EA	3 Yrs	Jasic

**Welder Inverters, Air Cooled, Arc**

Stock Code	System Code	Product	Output/Input	Duty Cycle	Weight	Uom	Brand
MX0840	F0000921	Industrial IGBT/MMA, VRD & ARC Force	160A, 220V	100%	10,0 Kg	EA	Reeflex
MX0815	F0000906	Industrial IGBT/MMA, VRD & ARC Force	200A, 220V	100%	10,0 Kg	EA	Reeflex
MX0816	F0000907	Industrial IGBT/MMA, VRD & ARC Force	200A, 380V	100%	10,0 Kg	EA	Reeflex
MX0820	F0000908	Industrial IGBT/MMA, VRD & ARC Force	200A, 525V	100%	10,0 Kg	EA	Reeflex
MX0831	F0000913	Industrial IGBT/MMA, VRD & ARC Force	300A, 380/525V	100%	17,0 Kg	EA	Reeflex
MX0835	F0000917	Industrial IGBT/MMA, VRD & ARC Force	300A, 525V	100%	17,0 Kg	EA	Reeflex
MX0836	F0000918	Industrial IGBT/MMA, VRD & ARC Force	400A, 380V	100%	23,0 Kg	EA	Reeflex



Holder Electrodes					
Stock Code	System Code	Type	Rating	Uom	Brand
WD0560	F0001039	Jaw Type	300A	EA	Octo
WD0570	F0001040	Jaw Type	600A	EA	Octo
WD0490	F0001032	Kd-Type	300A	EA	Octo
WD0500	F0001033	Kd-Type	500A	EA	Octo
WD0510	F0001034	Optimus	300A	EA	Octo
WD0520	F0001035	Optimus	400A	EA	Octo
WD0530	F0001036	Optimus	600A	EA	Octo
WD0540	F0001037	Twist Lock	400A	EA	Octo
WD0550	F0001038	Twist Lock	600A	EA	Octo



Optimus Type



Jaw Type



KD Type

Gouging Torches				
Stock Code	System Code	Rating	Uom	Brand
MX0920	F0000948	400/500/700A	EA	Octo



F0000948

Earth Clamps					
Stock Code	System Code	Type	Rating	Uom	Brand
WD0450	F0001027	Croco	300A	EA	Octo
WD0460	F0001028	Croco	400A	EA	Octo
WD0470	F0001029	Croco	500A	EA	Octo
WD0480	F0001030	G-Type, Brass	600A	EA	Octo
MX0885	F0000934	G-Type	500A	EA	Reeflex
MX0875	F0000933	Springhinge	400A	EA	Reeflex



F0001027



F0001028



F0001029



F0000933



F0000934



F0001030

Earth Clamps with Cables				
Stock Code	System Code	Type	Uom	Brand
OC0450	F0000958	3 m Cable, 16 mm, 160 Amp	EA	Octo
WD6120	F0001549	3 m Cable, 25 mm, 200-250 Amp	EA	Octo
WD6155	F0001555	3 m Cable, 50 mm, 400-500Amp	EA	Octo



F0001549



F0001555



F0000937



F0000929



F0000932



F0000936



F0000930

**Cable Kits**

Stock Code	System Code	Type/Rating	Size	Uom	Brand
MX0850	F0000929	No.16, for 160A 60%	4 m	KIT	Reeflex
MX0860	F0000930	No.25, for 160A/200A 100%	4 m	KIT	Reeflex
MX0870	F0000932	No.35, for 300A	5 m	KIT	Reeflex
MX0895	F0000936	No.50, for 400A/500A	5 m	KIT	Reeflex
MX0897	F0000937	No.70, for 700A	5 m	KIT	Reeflex



F0001010



F0001011



F0001013



F0001012



F0001016



F0001014



F0001015



F0001017



F0001019



F0001018

**Connector, Cable, Dinse Plug Female or Male, Panel Socket Female**

Stock Code	System Code	Type	Size/Rating	Uom
WD0300	F0001010	Bayonette Female	500A	EA
WD0310	F0001011	Bayonette Male	500A	EA
WD0330	F0001013	Dinse Female	10/25 mm	EA
WD0320	F0001012	Dinse Female	35/50	EA
WD0360	F0001016	Dinse Female	50/70	EA
WD0340	F0001014	Dinse Male	10/25 mm	EA
WD0350	F0001015	Dinse Male	35/50	EA
WD0370	F0001017	Dinse Male	50/70	EA
WD0390	F0001019	Panel Female	10/25 mm	EA
WD0380	F0001018	Panel Female	35/50 mm	EA

Cable Lugs			
Stock Code	System Code	Size	Uom
WD0600	F0001042	16 mm x 12 mm	EA
WD0400	F0001020	25 mm x 10 mm	EA
WD0610	F0001043	25 mm x 12 mm	EA
WD0620	F0001044	35 mm x 12 mm	EA
WD0630	F0001045	50 mm x 12 mm	EA
WD0640	F0001046	70 mm x 12 mm	EA



F0001042

Wire Cables					
Stock Code	System Code	Size	Colour	Length	Uom
WD0700	F0001054	16 mm <sup>2</sup>	Green	Cut to Length	Per Meter
WD0730	F0001057	25 mm <sup>2</sup>	Blue	Cut to Length	Per Meter
WD0760	F0001060	35 mm <sup>2</sup>	Grey	Cut to Length	Per Meter
WD0790	F0001063	50 mm <sup>2</sup>	Red	Cut to Length	Per Meter

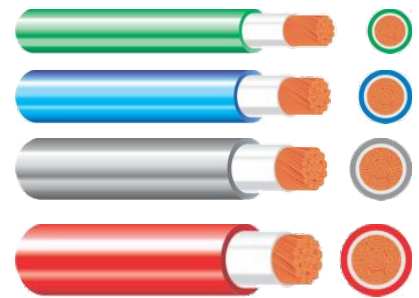

Electrodes						
Stock Code	System Code	Type	Size	Uom	Brand	
AX0200	F0000683	Hardface MMA	5.0 mm	P/Box	Afrox	
AX0220	F0000689	Stainless Steel 308L	2.5 mm	P/Box	Afrox	
AX0202	F0000685	Vitemax	2.5 mm	P/Box	Afrox	
AX0201	F0000684	Vitemax	3.15 mm	P/Box	Afrox	
AX0205	F0000686	Vitemax	4.0 mm	P/Box	Afrox	



F0000684

Electrodes			
System Code	Type	Size	Uom
F0001458	Cast Iron 55%	2.5 mm	P/Box
F0001459	Cast Iron 55%	3.15 mm	P/Box
F0001460	Cast Iron 55%	4.0 mm	P/Box
F0001461	Cast Iron 99%	2.5 mm	P/Box
F0001462	Cast Iron 99%	3.15 mm	P/Box
F0001463	Cast Iron 99%	4.0 mm	P/Box



F0001458

Electrode					
Stock Code	System Code	Type	Brand	Size	Uom
WD4990	F0001443	Iron Powder 7024	Atlantic	3.2 mm	5 Kg Box
WD5000	F0001444	Iron Powder 7024	Atlantic	4.0 mm	5 Kg Box
WD5010	F0001445	Iron Powder 7024	Matweld	5.0 mm	P/BOX



F0001443



Electrodes					
Stock Code	System Code	Type	Brand	Size	UOM
F0000333	F0000333	General Purpose 6013	OctoWeld	2.5 mm	1 Kg Box
F0000335	F0000335	General Purpose 6013	OctoWeld	2.5 mm	5 Kg Box
F0000334	F0000334	General Purpose 6013	OctoWeld	3.2 mm	1 Kg Box
F0000336	F0000336	General Purpose 6013	OctoWeld	3.2 mm	5 Kg Box
WD8070	F0001719	General Purpose 6013	Atlantic	2.5 mm	5 Kg Box
WD8071	F0001720	General Purpose 6013	Atlantic	3.2 mm	5 Kg Box
WD8072	F0001721	General Purpose 6013	Atlantic	4.0 mm	5 Kg Box



Low Hydrogen Electrodes					
Stock Code	System Code	Type	Brand	Size	UOM
WD8082	F0001731	Electrode Low Hydrogen E7018-1	Atlantic	2.5 mm	5 Kg Box
WD8083	F0001732	Electrode Low Hydrogen E7018-2	Atlantic	3.2 mm	5 Kg Box
WD8084	F0001733	Electrode Low Hydrogen E7018-3	Atlantic	4.0 mm	5 Kg Box



Electrode				
System Code	Type	Brand	Size	Uom
F0001446	Stainless Steel 308L	Atlantic	2.5 mm	2 Kg
F0001447	Stainless Steel 308L	Atlantic	3.2 mm	5 Kg
F0001448	Stainless Steel 308L	Atlantic	4.0 mm	5 Kg
F0001449	Stainless Steel 309L	Atlantic	2.5 mm	2 Kg
F0001450	Stainless Steel 309L	Atlantic	3.2 mm	5 Kg
F0001451	Stainless Steel 309L	Atlantic	4.0 mm	5 Kg
F0001455	Stainless Steel 312	Atlantic	2.5 mm	2 Kg
F0001456	Stainless Steel 312	Atlantic	3.2 mm	5 Kg
F0001457	Stainless Steel 312	Atlantic	4.0 mm	5 Kg
F0001452	Stainless Steel 316L	Atlantic	2.5 mm	2 Kg
F0001453	Stainless Steel 316L	Atlantic	3.2 mm	5 Kg
F0001454	Stainless Steel 316L	Atlantic	4.0 mm	5 Kg



Electrode Hot Box Ovens					
Stock Code	System Code	Type	Size	Uom	Brand
WD6005	F0001521	Hot Box	10 Kg, 220V	EA	Octo
WD6010	F0001522	Oven	100 Kg, 220V	EA	Octo



F0001522



F0001532



F0001559



F0001546



F0001547



F0000020



F0002857



F0001544

WELDING, CUTTING AND BRAZING

Mig/Mag Inverter Welder							
Stock Code	System Code	Product	Output/Input	Duty Cycle	Weight	Uom	Brand
WD6052	F0001532	Pro S/Board IGBT/MMA/MIG, VRD & ARC Force (N219)	160A, 220V	35%	12,5 Kg	EA	Jasic
WD6180	F0001559	Industrial IGBT/MMA/MIG, VRD Force (J92)	250A, 220V	40%	47,0 Kg	EA	Jasic
WD6181	F0001560	Industrial IGBT/MMA/MIG, VRD (N219)	250A, 380V	40%	47,0 Kg	EA	Jasic
WD6182	F0000020	Industrial IGBT/MMA/MIG, VRD (J93)	350A, 380V	40%	51,0 Kg	EA	Jasic
WD6105	F0001546	Industrial IGBT/MMA/MIG, VRD (J72)	350A, 380V	60%	45,0 Kg	EA	Jasic
WD6150	F0001554	Industrial IGBT/MMA/MIG, VRD (N291)	500A, 380V	60%	50,0 Kg	EA	Jasic
-	F0001547	Industrial MMA/TIG/MIG Inverter Synergic Pulse (N317)	400A, 380V	60%	40KG	EA	JASIC
-	F0002858	Industrial MMA/TIG/MIG Inverter Synergic (N387)	350A, 380V	50%	45KG	EA	JASIC
-	F0002857	Industrial MMA/TIG/MIG Inverter Synergic (N388)	500A, 380V	50%	53KG	EA	JASIC
WD6085	F0001544	Water Cooler For Mig500	4L Capacity			EA	Jasic



**Mig Torches**

Stock Code	System Code	Description	Cable Size	Amp	Brand
WD8670	F0001809	MIG Torch JS25 0,8 – 1,2 mm	4 m	230	Jasic
WD8671	F0001810	MIG Torch JS36 0,8 – 1,6 mm	4 m	340	Jasic
WD8672	F0001811	MIG Torch JS40 0,8 – 1,6 mm	4 m	400	Jasic
WD8673	F0001812	MIG Torch Spool Gun [Miller-type]	8 m	340	Jasic
WD8674	F0001813	MIG Torch 36KD DC 0,8 – 1,6 mm	3 m	340	OctoWeld
WD8675	F0001814	MIG Torch 40KD DC 0,8 – 1,6 mm	3 m	400	OctoWeld
WD4270	F0001378	MIG Torch MB15 0,8 – 1 mm	3 m	150	Binzel
WD4280	F0001379	MIG Torch AK25 60% 0,8 – 1,2 mm	4 m	230	Binzel
WD4290	F0001381	MIG Torch MB36 60% 0,8 – 1,6 mm	4 m	340	Binzel
WD4300	F0001383	MIG Torch MB40KD 60% 0,8 – 1,6 mm	4 m	400	Binzel
WD4330	F0001387	MIG Torch MB501 Water-Cooled	4 m	500	Binzel
MX0907	F0000942	MIG Torch MB 25 x 4 m	4 m	220	Reeflex
MX0909	F0000943	MIG Torch M0 36 x 4 m	4 m	400	Reeflex
MX0911	F0000944	MIG Torch MB 40 x 4 m	4 m	700	Reeflex



**Mig Body Plug Gun**

Stock Code	System Code	Type	Uom	Brand
WD3860	F0001309	Complete with Spring	EA	Octo



F0001309

**Mig Handles**

Stock Code	System Code	Type	Uom	Brand
WD3880	F0001311	Complete with Switch & Spring	EA	Octo



F0001311

**Mig Swan Neck**

Stock Code	System Code	Type	Uom	Brand
WD4211	F0001363	BNZ150	EA	Binzel
WD4212	F0001364	BNZ250	EA	Binzel
WD4213	F0001365	BNZ360	EA	Binzel
WD4214	F0001366	BNZ40 SN-5006E	EA	Binzel
WD4219	F0001371	BNZ501	EA	Binzel
WD4690	F0001426	TWC 64A60 #4	EA	Binzel
WD4660	F0001423	TWC 65A60 #5	EA	Binzel



F0001363

**Mig Central Adaptors**

Stock Code	System Code	Uom	Brand
WD3850	F0001308	EA	Binzel



F0001308

**Mig Cables**

Stock Code	System Code	Type	Size	Uom	Brand
WD4380	F0001392	Cable BNZ501	4 m	EA	Binzel
WD4340	F0001388	Cable BNZ150	4 m	EA	Binzel
WD4350	F0001389	Cable BNZ250	4 m	EA	Binzel
WD4360	F0001390	Cable BNZ360	4 m	EA	Binzel
WD4370	F0001391	Cable BNZ400	4 m	EA	Binzel
WD4410	F0001395	Complete Assy BNZ501	4 m	EA	Binzel
WD4390	F0001393	Conduit BNZ501	4 m	EA	Binzel
WD4400	F0001394	Gas BNZ501 Pipe	4 m	EA	Binzel



F0001392

F0001395

F0001393

F0001390

F0001394



Mig Liner				
Stock Code	System Code	Description	Uom	Brand
WD3980	F0001324	MIG Liner 4 m x 1/1,2 mm	EA	OctoWeld
WD3990	F0001325	MIG Liner 4 m x 1,4/1,6 mm	EA	OctoWeld
WD3995	F0001326	MIG Liner 4 m x 1,2 mm PVC red	EA	Binzel



Mig Nozzle/ Shrouds			
Stock Code	System Code	Description	Brand
WD4006	F0001328	Shroud MB15 Conical 12 mm	Binzel
WD4007	F0001329	Shroud MB25 Conical 15 mm	Binzel
WD4008	F0001330	Shroud MB36 Conical 16 mm	Binzel
WD4009	F0001331	Shroud MB40/MB501 Conical 16 mm	Binzel
WD4010	F0001332	BNZ150	Binzel
WD4020	F0001334	BNZ250	Binzel
WD4030	F0001335	BNZ360	Binzel
WD4040	F0001336	BNZ380/501	Binzel
WD4050	F0001337	BNZ400	Binzel



MIG NOZZLE/SHROUD

Mig Gas Diffusers			
Stock Code	System Code	Description	Brand
WD4420	F0001396	MIG Diffuser for MB36	OctoWeld
WD4430	F0001397	MIG Diffuser for MB40	OctoWeld
WD4443	F0001399	MIG Diffuser for MB36 White Gas	Binzel
WD4446	F0001400	MIG Diffuser for MB40 White Gas	Binzel
WD4440	F0001398	MIG Diffuser for MB501	Binzel



F0001399



F0001398

MIG Tip Holders			
Stock Code	System Code	Description	Brand
WD4055	F0001339	Contact Tip Holder AK15	Binzel
WD4060	F0001340	MIG Tip Holder M6 for MB15	OctoWeld
WD4070	F0001341	MIG Tip Holder M6 for MB25	OctoWeld
WD4080	F0001342	MIG Tip Holder M6 for MB36	OctoWeld
WD4090	F0001343	MIG Tip Holder (36KD) M8 for MB36	OctoWeld
WD4100	F0001344	MIG Tip Holder M8 for 40KD	OctoWeld



F0001340

F0001341

F00013421



F0001343



F0001344





MIG Contact Tips			
Stock Code	System Code	Description	Brand
WD4120	F0001904	Contact Tip MB15/25 0,8 mm M6 x 25	OctoWeld
WD4130	F0001347	Contact Tip MB15/25 0,9 mm M6 x 25	OctoWeld
WD4140	F0001348	Contact Tip MB15/25 1 mm M6 x 25	OctoWeld
WD4150	F0001349	Contact Tip MB15/25 1,2 mm M6 x 25	OctoWeld
WD4160	F0001350	Contact Tip MB36/40 0,8 mm M8 x 30	OctoWeld
WD4170	F0001351	Contact Tip MB36/40 1 mm M8 x 30	OctoWeld
WD4180	F0001352	Contact Tip MB36/40 1,2 mm M8 x 30	OctoWeld
WD4190	F0001353	Contact Tip MB36/40 1,6 mm M8 x 30	OctoWeld
WD4191	F0001354	Contact Tip MB15/25 0,8 mm M6 x 28	Binzel
WD4192	F0001355	Contact Tip MB15/25 1 mm M6 x 28	Binzel
WD4193	F0001356	Contact Tip MB15/25 1,2 mm M6 x 28	Binzel
WD4194	F0001357	Contact Tip MB36/40 0,8 mm M8 x 30	Binzel
WD4195	F0001358	Contact Tip MB36/40 1 mm M8 x 30	Binzel
WD4196	F0001359	Contact Tip MB36/40 1,2 mm M8 x 30	Binzel
WD4197	F0001360	Contact Tip MB501 1,6 mm M8 x 30	Binzel

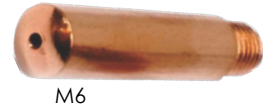

Trolley For The Mig Inverter				
Stock Code	System Code	Size	Uom	Brand
MX0960	F0000954	Single Bottle 220/300/400A	EA	Reeflex
MX0961	F0000955	Double Bottle 500/700A	EA	Reeflex



Inter Connector Cables					
Stock Code	System Code	Rating	Size	Uom	Brand
MX0899	F0000938	220A/300A	5 m x 35 mm	EA	Reeflex
MX0901	F0000939	400A/500A	5 m x 50 mm	EA	Reeflex
MX0903	F0000940	700A	5m x 70 mm	EA	Reeflex



MIG Wire					
Stock Code	System Code	Description	Type	Brand	Weight Per Roll
WD8020	F0001677	MIG Wire 0,8 mm ER70-6S	Mild Steel	Octoweld	15 Kg
WD8021	F0001678	MIG Wire 0,9 mm ER70-6S	Mild Steel	Octoweld	15 Kg
WD8022	F0001679	MIG Wire 1 mm ER70-6S	Mild Steel	Octoweld	15 Kg
WD8023	F0001680	MIG Wire 1,2 mm ER70-6S	Mild Steel	Octoweld	15 Kg
WD8062	F0001711	MIG Wire 0,8 mm ER308LSI	Stainless Steel	Octoweld	15 Kg
WD8063	F0001712	MIG Wire 0,9 mm ER308LSI	Stainless Steel	Octoweld	15 Kg
WD8064	F0001713	MIG Wire 1 mm ER308LSI	Stainless Steel	Octoweld	15 Kg
WD8065	F0001714	MIG Wire 1,2 mm ER308LSI	Stainless Steel	Octoweld	15 Kg
WD8066	F0001715	MIG Wire 0,8 mm ER309LSI	Mild Steel	Octoweld	15 Kg
WD8067	F0001716	MIG Wire 0,9 mm ER309LSI	Mild Steel	Octoweld	15 Kg
WD8068	F0001717	MIG Wire 1 mm ER309LSI	Mild Steel	Octoweld	15 Kg
WD8069	F0001718	MIG Wire 1,2 mm ER309LSI	Mild Steel	Octoweld	15 Kg
WD8051	F0001702	MIG Wire 0,8 mm ER316LSI	Stainless Steel	Octoweld	15 Kg
WD8052	F0001703	MIG Wire 0,9 mm ER316LSI	Stainless Steel	Octoweld	15 Kg
WD8053	F0001704	MIG Wire 1 mm ER316LSI	Stainless Steel	Octoweld	15 Kg
WD8054	F0001705	MIG Wire 1,2 mm ER316LSI	Stainless Steel	Octoweld	15 Kg



MIG Wires					
Stock Code	System Code	Description	Type	Brand	Weight Per Roll
WD8025	F0001681	MIG Wire 0,8 mm ER70-6S	Mild Steel	Atlantic	15 Kg
WD8026	F0001682	MIG Wire 0,9 mm ER70-6S	Mild Steel	Atlantic	15 Kg
WD8027	F0001907	MIG Wire 1 mm ER70-6S	Mild Steel	Atlantic	15 Kg
WD2028	F0001908	MIG Wire 1,2 mm ER70-6S	Mild Steel	Atlantic	15 Kg
WD8037	F0001690	MIG Wire 1 mm ER100S	Low Alloy	Atlantic	15 Kg
WD8038	F0001691	MIG Wire 1,2 mm ER100S	Low Alloy	Atlantic	15 Kg
WD8030	F0001684	MIG Wire Flux-Cored E71T-1C 1,2 mm	Mild Steel	Atlantic	15 Kg
WD8031	F0001685	MIG Wire Flux-Cored E71T-1C 1,6 mm	Mild Steel	Atlantic	15 Kg
WD8040	F0001693	MIG Wire 1,2 mm ER4043	Aluminium	Atlantic	P/Roll
WD8041	F0001694	MIG Wire 1,6 mm ER4043	Aluminium	Atlantic	P/Roll
WD8042	F0001695	MIG Wire 1,2 mm ER5356	Aluminium	Atlantic	P/Roll
WD8043	F0001696	MIG Wire 1,6 mm ER5356	Aluminium	Atlantic	P/Roll





WELDING, CUTTING AND BRAZING



F0002834



F0002861



F0001533



F0001539



F0002797

**Welder Inverters TIG/MMA, AC/DC**

Stock Code	System Code	Product Model	Output/Input	Duty Cycle	Weight	Uom	Brand
WD6053	F0001533	ProS/Board Hi Frequency, TIG (W206)	180A, 220V	35%	6 Kg	EA	OCTO
-	F0002861	Industrial Hi Frequency, TIG 180 (W223)	180A, 200V	30%	6 Kg	EA	OctoWeld
-	F0002834	Industrial Hi Frequency, TIG 200 Pulse (W224)	200A, 220V	30%	7 Kg	EA	JASIC
-	F0002797	Industrial Hi Frequency, TIG 200 AC/DC Pulse (E201)	200A, 220V	25%	9 Kg	EA	JASIC
-	F0000024	Industrial Hi Frequency, TIG 315 AC/DC Pulse (E103)	315A, 380V	30%	25 Kg	EA	JASIC

**Foot Controllers**

Stock Code	System Code	Type	Uom	Brand
WD6055	F0001535	AC/DC	EA	Octo



F0001535



TIG Torch					
Stock Code	System Code	Type	Size	Uom	Brand
WD8652	F0001807	26V, 2PC (L)	4 m	EA	Octo
WD8653	F0001808	26V, 2PC (L)	8 m	EA	Octo
WD8650	F0001805	18 Water Cooled	5 m	EA	Octo
WD7241	F0001646	WP9V	8 m	EA	Octo

TIG Body Torches with Handle				
Stock Code	System Code	Type	Uom	Brand
WD3430	F0001269	17V	EA	Octo
WD3440	F0001270	18V	EA	Octo
WD3450	F0001271	26	EA	Octo
WD3460	F0001272	26V	EA	Octo



TIG Valves				
Stock Code	System Code	Type	Uom	Brand
WD3380	F0001264	17V VS2	EA	Octo
WD3390	F0001265	26V VS1	EA	Octo



TIG Back Caps				
Stock Code	System Code	Type	Uom	Brand
WD3350	F0001258	Long 57Y02	EA	Octo
WD3360	F0001259	Short 57Y04	EA	Octo



TIG Handles				
Stock Code	System Code	Type	Uom	Brand
WD3410	F0001267	Ribbed 18/26/26V	EA	Octo



TIG Switches				
Stock Code	System Code	Type	Uom	Brand
WD3490	F0001276	SW-1F	EA	Octo



TIG Rubber Boot Switch				
Stock Code	System Code	Type	Uom	Brand
WD3510	F0001278	Small 17	EA	Octo
WD3500	F0001277	Large 18/26	EA	Octo



TIG Collets					
Stock Code	System Code	Type	Size	Uom	Brand
WD3220	F0001241	10N23	1.6 mm	EA	Octo
WD3230	F0001242	10N24	2.4 mm	EA	Octo
WD3260	F0001245	STUBBY, 10N24S	2.4 mm	EA	Octo
WD3240	F0001243	10N25	3.2 mm	EA	Octo
WD3250	F0001244	10N20	4.0 mm	EA	Octo

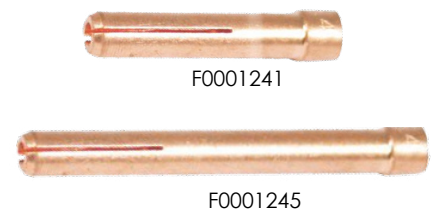

WELDING, CUTTING AND BRAZING



TIG Body Collets					
Stock Code	System Code	Type	Size	Uom	Brand
WD3270	F0001248	10N31	1.6 mm	EA	Octo
WD3280	F0001249	10N32	2.4 mm	EA	Octo
WD3290	F0001250	10N28	3.2 mm	EA	Octo
WD3300	F0001251	406488	4.0 mm	EA	Octo
WD3310	F0001252	17CB2024	Stubby	EA	Octo



TIG Body Collet Gas Lens				
Stock Code	System Code	Size	Uom	Brand
WD3320	F0001255	1.6 mm	EA	Octo
WD3330	F0001256	2.4 mm	EA	Octo
WD3340	F0001257	3.2 mm	EA	Octo



TIG, Connectors				
Stock Code	System Code	Type	Uom	Brand
WD3560	F0001283	Cable & Hose 17 2 Pc	Kit	Octo
WD3570	F0001284	Cable & Hose 26 2 Pc	Kit	Octo



TIG, Nuts & Nipples					
Stock Code	System Code	Type	Size	Uom	Brand
WD3540	F0001281	Female Right Hand	3/8"	EA	Octo
WD3530	F0001280	Male Left Hand	3/8"	EA	Octo
WD3520	F0001279	Male Right Hand	3/8"	EA	Octo



TIG, Power Cables					
Stock Code	System Code	Type	Size	Uom	Brand
WD3470	F0001273	H20	18 mm x 4 m	EA	Octo
WD3480	F0001274	H20	18 mm x 8 m	EA	Octo
WD3481	F0001275	TIG Hose Black Braid	4 mm	EA	Octo



TIG, Alumina Cups					
Stock Code	System Code	Type	Size	Uom	Brand
WD3100	F0001221	#4 10N50	6 mm	EA	Octo
WD3110	F0001222	#5 10N49	8 mm	EA	Octo
WD3120	F0001223	#6 10N48	9 mm	EA	Octo
WD3130	F0001224	#7 10N47	11 mm	EA	Octo
WD3140	F0001225	#8 10N46	13 mm	EA	Octo
WD3150	F0001226	#10 10N45	16 mm	EA	Octo



Item	Components
1.1	Torch Body
1.2	Torch Body (Flexible)
1.3	Torch Body (Valve)
2	Long Back Cap
3	Short Back Cap
4	Gasket
5	Stubby Gasket

Item	Components
6	Collet
7	Stubby Collet
8	Collet Body
9	Stubby Collet Body
10.1	Ceramic Nozzle
10.2	Extra-Length Ceramic Nozzle
10.3	Stubby Ceramic Nozzle

Item	Components
10.4	Ceramic Nozzle
10.5	Extra Long Ceramic Nozzle
10.6	Extra Diameter Ceramic Nozzle
11	Switch (with Wire)
12	Handle
13	Cable Assembly
14	Valve Stem

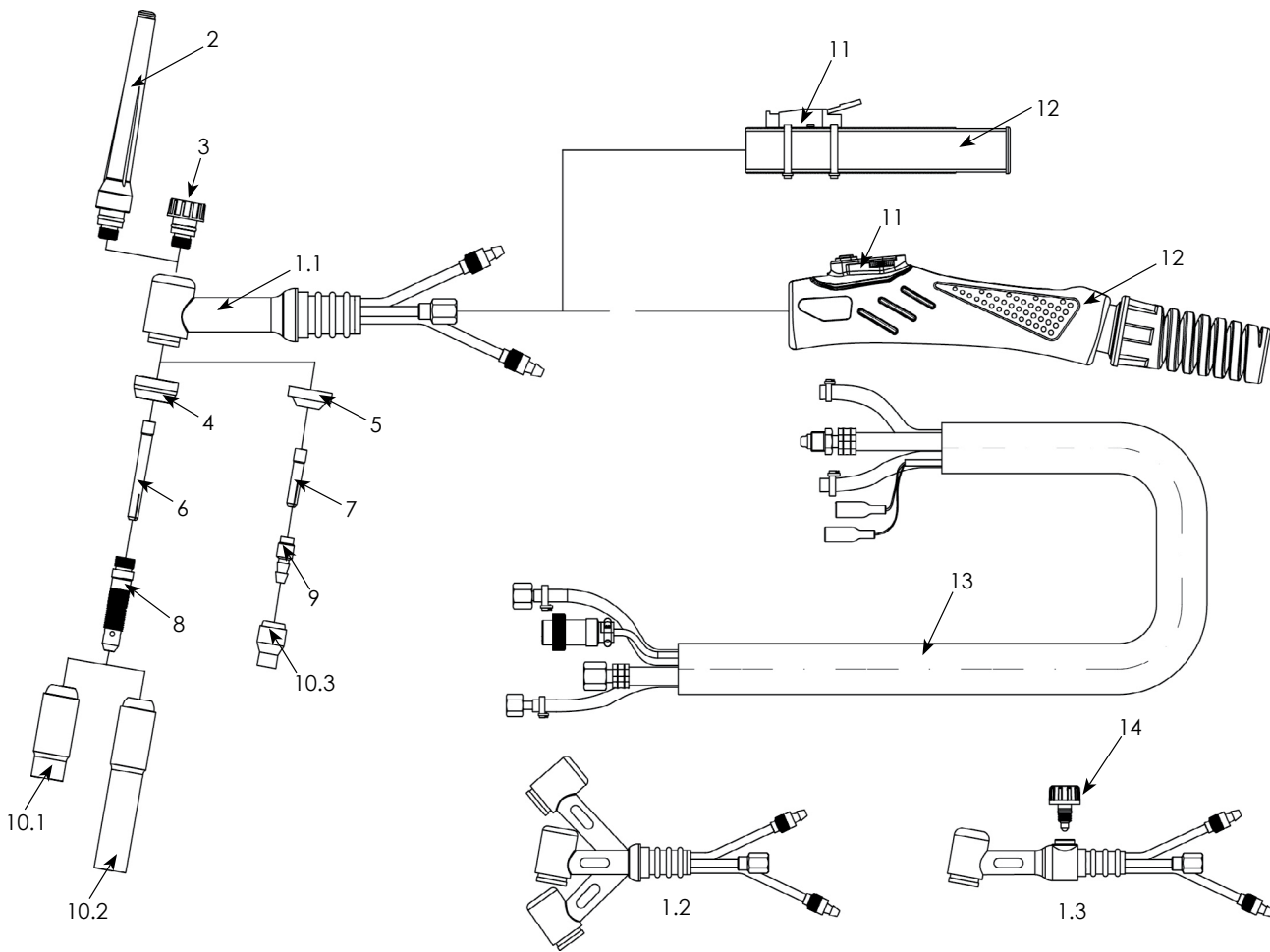

Tig Gas Lens Alumina Cups					
Stock Code	System Code	Type	Size	Uom	Brand
WD3160	F0001235	#5	8 mm	EA	Octo
WD3170	F0001236	#6	10 mm	EA	Octo
WD3180	F0001237	#7	11 mm	EA	Octo
WD3190	F0001238	#8	12 mm	EA	Octo



F0001235

Tig Alumina Nozzles				
Stock Code	System Code	Type	Uom	Brand
WD3200	F0001239	#5 53N59	EA	Octo
WD3210	F0001240	#6 53N60	EA	Octo



F0001239

Tig Tungsten Electrodes			
Stock Code	System Code	Description	Brand
WD8900	F0001838	TIG Electrode for Red Tip 1,6 mm	OctoWeld
WD8901	F0001839	TIG Electrode for Red Tip 2,4 mm	OctoWeld
WD8902	F0001840	TIG Electrodefor Red Tip 3,2 mm OCT	OctoWeld
WD8910	F0001841	TIG Electrode White Aluminum Tip 1,6 mm-R8	OctoWeld
WD8911	F0001842	TIG Electrode White Aluminum Tip 2,4 mm-R8	OctoWeld
WD8912	F0001843	TIG Electrode White Aluminum Tip 3,2 mm-R8	OctoWeld

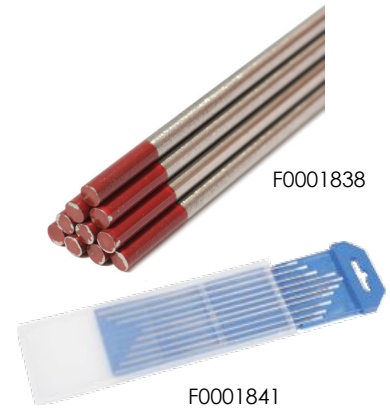

Tig Tungsten Electrodes				
System Code	Type	Size	Pack	Uom
F0001288	Thoriated 2%, Red	1.6 mm	10 Per Pack	PK
F0001289	Thoriated 2%, Red	2.4 mm	10 Per Pack	PK
F0001290	Thoriated 2%, Red	3.2 mm	10 Per Pack	PK
F0001291	Zirconiated 2%, White	1.6 mm	10 Per Pack	PK
F0001292	Zirconiated 2%, White	2.4 mm	10 Per Pack	PK
F0001293	Zirconiated 2%, White	3.2 mm	10 Per Pack	PK
F0001294	Zirconiated 2%, White	4.0 mm	10 Per Pack	PK

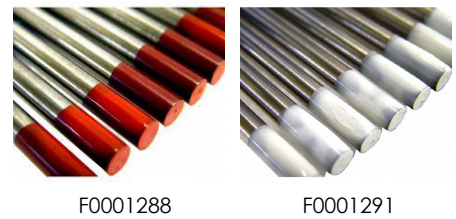

Tig Welding Wires				
Stock Code	System Code	Description	For Welding Materials	Brand
WD8180	F0001747	Wire TIG ER70S-6 1,6 mm	Mild Steel	Atlantic
WD8182	F0001748	Wire TIG ER70S-6 2,4 mm	Mild Steel	Atlantic
WD8185	F0001749	Wire TIG 308LSi 1,6 mm	Stainless Steel	OctoWeld
WD8186	F0001750	Wire TIG 308LSi 2,4 mm	Stainless Steel	OctoWeld
WD8188	F0001751	Wire TIG 309LSi 1,6 mm	Stainless Steel	OctoWeld
WD8189	F0001752	Wire TIG 309LSi 2,4 mm	Stainless Steel	OctoWeld
WD8192	F0001753	Wire TIG 316LSi 1,6 mm	Stainless Steel	OctoWeld
WD8193	F0001754	Wire TIG 316LSi 2,4 mm	Stainless Steel	OctoWeld



Tig Wire Rod				
System Code	Type	Size	Pack	Uom
F0001487	Aluminium ER4043	1.6 mm	5 Kg	PK
F0001488	Aluminium ER4043	2.4 mm	5 Kg	PK
F0001489	Aluminium ER4043	3.2 mm	5 Kg	PK
F0001490	Aluminium ER5356	1.6 mm	5 Kg	PK
F0001491	Aluminium ER5356	2.4 mm	5 Kg	PK
F0001492	Aluminium ER5356	3.2 mm	5 Kg	PK





F0001856



F0002872



F0002873

Plasma Cutters									
Stock Code	System Code	Product	Cutting Capacity		Output/ Input	Duty Cycle	Weight	Uom	Brand
WD6235	F0001856	Cutter, Plasma Cut 60	12 mm (Mild)	6 mm (Stainless)	55A, 380V	60%	8,6 Kg	EA	Jasic
WD6240	F0002872	Cutter, Plasma Cut 120	25 mm (Mild)	16 mm (Stainless)	110A, 380V	60%	36 Kg	EA	Jasic
WD6101	F0002873	Cutter, Plasma Cut 160	40 mm (Mild)	30 mm (Stainless)	160A, 380V	60%	46 Kg	EA	Jasic





Complete Plasma Torches				
Stock Code	System Code	Type	Uom	Brand
WD6320	F0001591	A81	EA	Octo
WD6321	F0001592	PT31	EA	Octo
WD6322	F0000063	A141	EA	Octo



Plasma Air Diffusers				
Stock Code	System Code	Type	Uom	Brand
WD6470	F0001614	A81	EA	Octo
WD6460	F0001611	A141	EA	Octo
WD6461	F0001612	A151	EA	Octo



Plasma Electrodes				
Stock Code	System Code	Type	Uom	Brand
WD6500	F0001618	PT-31	EA	Octo
WD6490	F0001617	A81	EA	Octo
WD6480	F0001615	-	EA	Octo
WD6481	F0001616	-	EA	Octo

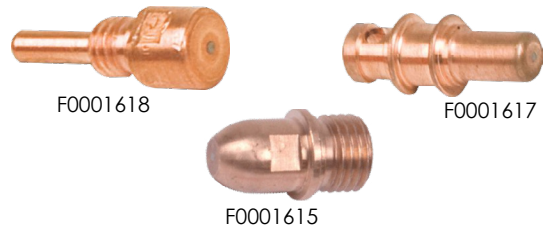

Plasma Outer Nozzle				
Stock Code	System Code	Type	Uom	Brand
WD6370	F0001599	PT-31	EA	Octo
WD6360	F0001598	A81	EA	Octo
WD6350	F0001597	A141	EA	Octo



Stand Off Guide Plasma				
Stock Code	System Code	Type	Uom	Brand
WD6310	F0001590	A81	EA	Octo
WD6300	F0001589	A101	EA	Octo



Plasma Tips					
Stock Code	System Code	Type	Size	Uom	Brand
WD6420	F0001605	PT-31	0.8 mm	EA	Octo
WD6430	F0001606	A141	1.0 mm	EA	Octo
WD6440	F0001607	A151	1.0 mm	EA	Octo
WD6450	F0001608	A81	1.2 mm	EA	Octo
AX0175	F0000677	Plasma 38	-	EA	Afrox



Gas Welding Torches				
Stock Code	System Code	Description	R.C.C.	Brand
WD1340	F0001100	Torch Gas Cutting Black Handle 3/8" Universal	300 mm	OctoWeld
WD1350	F0001101	Torch Gas Cutting/Welding Brass Handle 3/8" Universal	300 mm	OctoWeld
WD1370	DISC	Torch Gas Cutting/Welding Brass Monarch Type OXY/ACTET	300 mm	OctoWeld
HR0190	F0000785	Torch Gas Cutting Straight Brass 62-5F 3/8" Low Pressure Universal	300 mm	Harris
HR0192	F0000786	Torch Gas Cutting Straight Brass 62-5F 9/16" Low Pressure Universal	300 mm	Harris
HR0185	F0000783	Torch Gas Cutting Brass Handle Model 28 Type 9/16" LPG/ACET	400 mm	Harris
HR0187	F0000784	Torch Gas Cutting Brass Handle Model H28 Type 9/16" LPG/ACET	350 mm	Harris
HR0080	F0000782	Torch Gas Cutting Brass Handle 242-NM 3/8" Universal	200 mm	Harris
HR0060	F0000756	Cutting Attachment, Radius Cutter Model 69 A 600 mm	300 mm	Harris
RA0005	F0000961	Cutting Attachment, Radius Cutter Model 69 A Type 600 mm	300 mm	OctoWeld
WD3000	F0001219	Cutter, Straight Line + 2 x 1,8 m Tracks 180-800 mm/min	60 mm	OctoWeld
WD3010	F0001220	Straight Line Cutter Track 1,8 m	N/A	OctoWeld

Torch Accessories				
Stock Code	System Code	Type	Uom	Brand
WD2520	F0001183	Handle, LPG	EA	Octo
WD2510	F0001182	Handle, LPG, Economizer	EA	Octo
WD1310	F0001098	Handle/Shank EN	EA	Octo
WD1300	F0001097	Acetylene/Propane Use, 90' Brass Head	EA	Octo

Gas Flashback Arrestors			
Stock Code	System Code	Description	Brand
HR0200	F0000787	Arrestor Flashback Oxygen/Reg Mount 188TRGB 3/8"	Harris
HR0202	F0000789	Arrestor Flashback Oxygen/Reg Mount 188TR 9/16"	Harris
HR0201	F0000788	Arrestor Flashback Oxygen/Torch Mount 188-1R8GB 3/8"	Harris
HR0203	F0000790	Arrestor Flashback Oxygen/Torch Mount 188-1R8 9/16"	Harris
HR0211	F0000792	Arrestor Flashback Acetylene/Reg Mount 188TLGB 3/8"	Harris
HR0218	F0000799	Arrestor Flashback Acetylene/Reg Mount 188TL 9/16"	Harris
HR0217	F0000798	Arrestor Flashback Acetylene/Torch Mount 188-1L8GB 3/8"	Harris
HR0215	F0000796	Arrestor Flashback Acetylene/Torch Mount 188-1L8 9/16"	Harris
WD1550	F0001113	Arrestor Flashback Oxygen/Torch Mount 3/8"	Octoweld
WD1555	F0001114	Arrestor Flashback Oxygen/Reg Mount 3/8"	Octoweld
WD1560	F0001115	Arrestor Flashback Acetylene/Torch Mount 3/8"	Octoweld
WD1565	F0001116	Arrestor Flashback Acetylene/Reg Mount 3/8"	Octoweld

Bull Nose Stems				
Stock Code	System Code	Type	Uom	Brand
WD1600	F0001119	Standard, 25A06D	EA	Octo
WD1630	F0001122	Long, 110 mm	EA	Octo

Bull Nose Nuts				
Stock Code	System Code	Type	Uom	Brand
WD1610	F0001120	Acetylene	EA	Octo
WD1620	F0001121	Oxygen	EA	Octo

Hose Nuts					
Stock Code	System Code	Type	Size	Uom	Brand
WD1670	F0001125	Left Hand, Acetylene	3/8"	EA	Octo
WD1660	F0001124	Right Hand Oxygen	3/8"	EA	Octo

Hose Tail Pieces					
Stock Code	System Code	Type	Size	Uom	Brand
WD1680	F0001126	986	3/8"	EA	Octo



WELDING, CUTTING AND BRAZING



**Cutting Nozzles**

Stock Code	System Code	Description	R.C.C	Type	Brand
WD1970	F0001146	Nozzle Gas ANM #1	3 – 6 mm	Oxygen/Acetylene	OctoWeld
WD1990	F0001148	Nozzle Gas ANM #2	6 – 12 mm	Oxygen/Acetylene	OctoWeld
WD2010	F0001150	Nozzle Gas ANM #3	12 – 75 mm	Oxygen/Acetylene	OctoWeld
WD2020	F0001151	Nozzle Gas ANM #4	75 – 100 mm	Oxygen/Acetylene	OctoWeld
WD2030	F0001151	Nozzle Gas ANM #5	100 – 150 mm	Oxygen/Acetylene	OctoWeld
WD8920	F0001844	Nozzle Gas ANM #6	150 – 300 mm	Oxygen/Acetylene	OctoWeld
WD2040	F0001153	Nozzle Gas ANME #1	3 – 6 mm	Oxygen/Acetylene	OctoWeld
WD2050	F0001154	Nozzle Gas ANME #2	6 – 12 mm	Oxygen/Acetylene	OctoWeld
WD2060	F0001155	Nozzle Gas ANME #3	12 – 75 mm	Oxygen/Acetylene	OctoWeld
WD2070	F0001156	Nozzle Gas ANME #4	75 – 100 mm	Oxygen/Acetylene	OctoWeld
WD2080	F0001157	Nozzle Gas ANME #5	100 – 150 mm	Oxygen/Acetylene	OctoWeld
WD8924	F0001846	Nozzle Gas ANME #7	50 – 300 mm	Oxygen/Acetylene	OctoWeld
WD2240	F0001173	Nozzle Gas 6290NX0	10 – 15 mm	Oxygen/Propane Gas	OctoWeld
WD2230	F0001172	Nozzle Gas 6290NX00	5 – 10 mm	Oxygen/Propane Gas	OctoWeld
WD2250	F0001174	Nozzle Gas 6290NX1	15-25 mm	Oxygen/Propane Gas	OctoWeld
WD2260	F0001175	Nozzle Gas 6290NX2	25-50 mm	Oxygen/Propane Gas	OctoWeld
WD2270	F0001176	Nozzle Gas 6290NX4	75-150 mm	Oxygen/Propane Gas	OctoWeld
WD2280	F0001177	Nozzle Gas 6290NX6	150-300 mm	Oxygen/Propane Gas	OctoWeld
WD2290	F0002915	Nozzle Gas 2890-F1	0-10 mm	Oxygen/Acetylene	OctoWeld
WD2300	F0001178	Nozzle Gas 2890-F2	10-50 mm	Oxygen/Acetylene	OctoWeld
WD2310	F0001179	Nozzle Gas 2890-F3	50-100 mm	Oxygen/Acetylene	OctoWeld
WD2320	F0001180	Nozzle Gas 2890-F4	100-125 mm	Oxygen/Acetylene	OctoWeld
WD2090	F0001158	Nozzle Gas PNM #1	3-6 mm	Oxygen/Propane Gas	OctoWeld
WD2110	F0001160	Nozzle Gas PNM #2	6-12 mm	Oxygen/Propane Gas	OctoWeld
WD2130	F0001162	Nozzle Gas PNM #3	12-75 mm	Oxygen/Propane Gas	OctoWeld
WD2140	F0001163	Nozzle Gas PNM #4	75-100 mm	Oxygen/Propane Gas	OctoWeld
WD2150	F0001164	Nozzle Gas PNM #5	100-150 mm	Oxygen/Propane Gas	OctoWeld
WD2160	F0001165	Nozzle Gas PNM #6	150-300 mm	Oxygen/Propane Gas	OctoWeld
WD2170	F0001166	Nozzle Gas PNME #1	3-6 mm	Oxygen/Propane Gas	OctoWeld
WD2180	F0001167	Nozzle Gas PNME #2	6-12 mm	Oxygen/Propane Gas	OctoWeld
WD2190	F0001168	Nozzle Gas PNME #3	12-75 mm	Oxygen/Propane Gas	OctoWeld
WD2200	F0001169	Nozzle Gas PNME #4	75-100 mm	Oxygen/Propane Gas	OctoWeld
WD2210	F0001170	Nozzle Gas PNME #5	100-150 mm	Oxygen/Propane Gas	OctoWeld
WD2220	F0001171	Nozzle Gas PNME #6	150-300 mm	Oxygen/Propane Gas	OctoWeld
HR0101	F0000758	Nozzle Gas 2890-1F	12,7 mm	Oxygen/Acetylene	Harris
HR0102	F0000759	Nozzle Gas 2890-2F	38 mm	Oxygen/Acetylene	Harris



ANM



NX



Cutting Nozzles					
Stock Code	System Code	Description	Size	Type	Brand
HR0103	F0000760	Nozzle Gas 2890-3F	50-100 mm	Oxygen/Acetylene	Harris
HR0104	F0000761	Nozzle Gas 2890-4F	100-125 mm	Oxygen/Acetylene	Harris
HR0100	F0000757	Nozzle Gas 2890-0F	0-3,2 mm	Oxygen/Acetylene	Harris
HR0120	F0000762	Nozzle Gas 6290-1 NFF	15-25 mm	Oxygen/Propane Gas	Harris
HR0121	F0000763	Nozzle Gas 6290-2 NFF	25-50 mm	Oxygen/Propane Gas	Harris
HR0122	F0000764	Nozzle Gas 6290-3 NFF	50-75 mm	Oxygen/Propane Gas	Harris
HR0124	F0000765	Nozzle Gas 6290-4 NFF	75-150 mm	Oxygen/Propane Gas	Harris
HR0128	F0000767	Nozzle Gas 6290-000NX	0-5 mm	Propane Gas	Harris
HR0129	F0000768	Nozzle Gas 6290-00NX	5-10 mm	Propane Gas	Harris
HR0130	F0000769	Nozzle Gas 6290-0NX	10-15 mm	Propane Gas	Harris
HR0131	F0000770	Nozzle Gas 6290-1NX	15-25 mm	Propane Gas	Harris
HR0132	F0000771	Nozzle Gas 6290-3NX	25-50 mm	Propane Gas	Harris
HR0126	F0000766	Nozzle Gas 6290-4NX	50-75 mm	Propane Gas	Harris
HR0133	F0000772	Nozzle Gas 8290-1ANM	0-6 mm	Universal/Mixed Gas	Harris
HR0134	F0000773	Nozzle Gas 8290-2ANM	6-12 mm	Universal/Mixed Gas	Harris
HR0135	F0000774	Nozzle Gas 8290-3ANM	12-75 mm	Universal/Mixed Gas	Harris
HR0136	F0000775	Nozzle Gas 8290-4ANM	75-150 mm	Universal/Mixed Gas	Harris
HR0137	F0000776	Nozzle Gas 8290-5ANM	150-200 mm	Universal/Mixed Gas	Harris
HR0140	F0000777	Nozzle Gas 8290-P1	0-6 mm	Universal/Mixed Gas	Harris
HR0141	F0000778	Nozzle Gas 8290-P2	6-12 mm	Universal/Mixed Gas	Harris
HR0142	F0000779	Nozzle Gas 8290-P3	12-75 mm	Universal/Mixed Gas	Harris
HR0143	F0000780	Nozzle Gas 8290-P4	75-150 mm	Universal/Mixed Gas	Harris



F-Series

Heating Nozzles				
Stock Code	System Code	Type	Uom	Brand
WD1900	F0001139	Oxy Propane No. 2 2290-2H	EA	Octo
WD1910	F0001140	Oxy Propane No. 3 2290-3H	EA	Octo
WD1920	F0001141	Oxy Propane No. 4 2290-4H	EA	Octo
WD1930	F0001142	Oxy Propane No. 5 2290-5H	EA	Octo
AX0140	F0000673	Oxy - LPG 010-410-H5	EA	Afrox



F0001139

Welding Nozzles			
Stock Code	System Code	Type	Uom
WD1940	F0001143	Swadged #3	EA
WD1950	F0001144	Swadged #5	EA
WD1960	F0001145	Swadged #7	EA



F0001143

LPG Burners				
Stock Code	System Code	Size	Uom	Brand
WD2600	F0001187	19 mm	EA	Octo
WD2610	F0001188	25 mm	EA	Octo
WD2630	F0001189	32 mm	EA	Octo
WD2640	F0001190	42 mm	EA	Octo

Nozzle Cleaners				
Stock Code	System Code	Type	Uom	Brand
HR0010	F0001136	Standard	EA	Octo

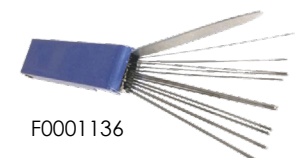

F0001136



Neck Tubes				
Stock Code	System Code	Size	Uom	Brand
WD2560	F0001185	70 mm	EA	Octo
WD2550	F0001184	180 mm	EA	Octo
WD2570	F0001186	750 mm	EA	Octo



Using Flashback Arrestors For Gas Cutting And Welding

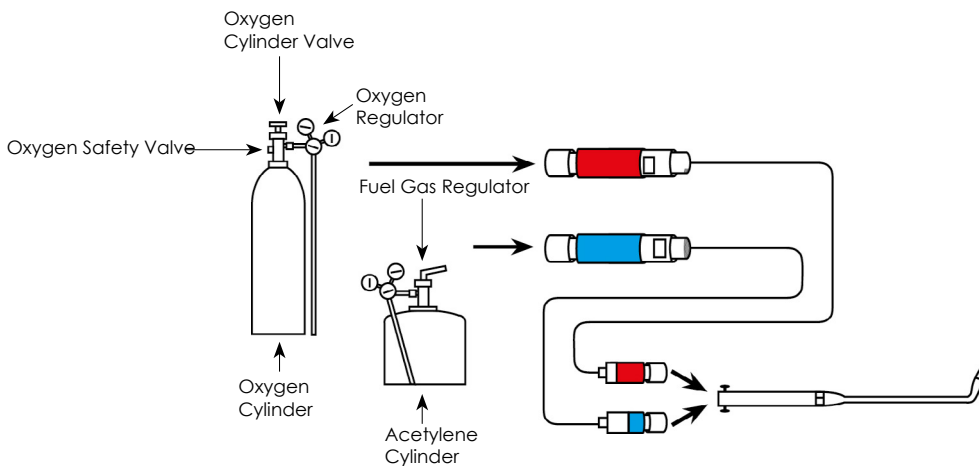

Regulators						
Stock Code	System Code	Type	Connection	Gas Type	Uom	Brand
HR0261	F0000817	Single Stage with Gauges, 825150Ac	3/8"	Acetylene	EA	Harris
HR0251	F0000813	Single Stage with Gauges, 801D-1.5-Ac	3/8"	Acetylene	EA	Harris
HR0250	F0000812	Single Stage with Gauges, 801D-10-Ox	3/8"	Oxygen	EA	Harris
HR0271	F0000819	Double Stage with Gauges, 896150Ac	9/16"	Acetylene	EA	Harris
HR0270	F0000818	Double Stage with Gauges, 825D-10-Ox	9/16"	Oxygen	EA	Harris
HR0273	F0000821	Double Stage, 899150Ac-Gaugeless	9/16"	Acetylene	EA	Harris
HR0272	F0000820	Double Stage, 899D-10-Gaugeless	9/16"	Oxygen	EA	Harris
HR0252	F0000814	Flowmeter with Gauge & Flow Tube, 801D-1.5-F-Ar	3/8"	Argon	EA	Harris
HR0254	F0000815	Single Stage with Gauge, 801-4-Lp	3/8"	LPG	EA	Harris
WD2710	F0001198	Heavy-Duty Single Stage with Gauges	3/8"	Acetylene	EA	OctoWeld
WD2790	F0001204	Heavy-Duty Single Stage with Gauges	3/8"	Oxygen	EA	OctoWeld
WD2700	F0001197	Heavy-Duty Multi Stage with Gauges	3/8"	Acetylene	EA	Octo
WD2760	F0001202	Heavy-Duty Multi Stage with Gauges	3/8"	Oxygen	EA	Octo
WD2740	F0001200	Regulator Flowmeter Argon/Co2	3/8"	Argon/Co <sup>2</sup>	EA	Octo



Radius Cutters			
Stock Code	System Code	Uom	Brand
HR0060	F0000756	EA	Harris
RA0005	F0000961	EA	Octo

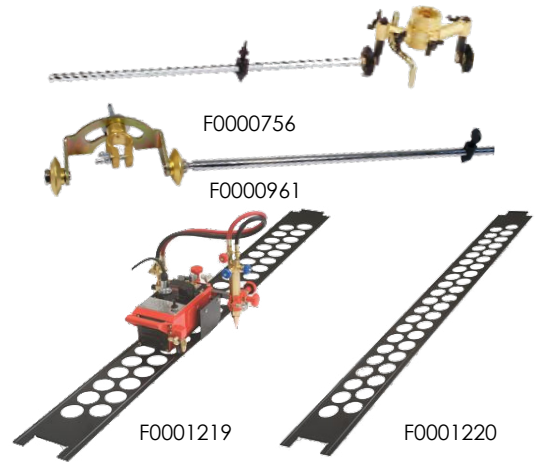

Straight Line Cutters (Quickie)				
Stock Code	System Code	Type	Uom	Brand
WD3000	F0001219	Cutter with 2 Tracks	KIT	Octo
WD3010	F0001220	1.8 m Extension Extra Track	EA	Octo

Brazing Rods				
Stock Code	System Code	Type	Size	Uom
WD5280	F0001905	Bare	2.0 mm - 10 Kg	EA
WD5270	F0001476	Flux Coated	2.0 mm - 5 Kg	EA
WD5290	F0001477	Flux Coated	3.0 mm - 5 Kg	EA



Copper-to-Copper Brazing Rods				
Stock Code	System Code	Size	Silver Grade	Uom
WD5670	F0001501	2 mm - 1 Kg	0%	EA
WD5690	F0001503	2 mm - 1 Kg	2%	EA
WD5710	F0001505	2 mm - 1 Kg	5%	EA
WD5730	F0001507	2 mm - 1 Kg	15%	EA
WD5680	F0001502	3 mm - 1 Kg	0%	EA
WD5700	F0001504	3 mm - 1 Kg	2%	EA
WD5720	F0001506	3 mm - 1 Kg	5%	EA
WD5740	F0001508	3 mm - 1 Kg	15%	EA

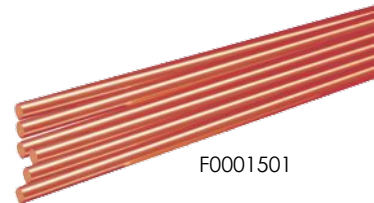

Silver Solders					
Stock Code	System Code	Type	Silver %	Size	Pack Size
WD5640	F0001496	Flux Coated, White	20	1.5 mm	1 Kg
WD5650	F0001497	Flux Coated, Blue	30	1.5 mm	1 Kg
WD5660	F0001499	Flux Coated, Yellow	40	1.5 mm	1 Kg

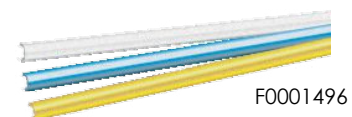
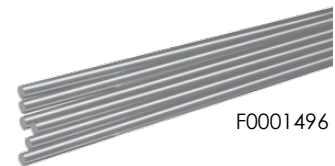

Gas Cylinder Trolleys				
Stock Code	System Code	Type	Uom	Brand
WD7200	F0001637	Single Bottle	EA	Octo
WD7201	F0001638	Double Bottle	EA	Octo





WELDING, CUTTING AND BRAZING

**Welding Hoses**

Stock Code	System Code	Type	Size	Uom	Brand
WD2830	F0001209	Acetylene, Red	8 mm	Roll	Octo
WD2840	F0001211	Oxygen, Blue	8 mm	Roll	Octo



F0001208



F0001211

**Clamp Hoses**

Stock Code	System Code	Type	Size	Uom	Brand
AX0150	A0004464	O-Clamp	8 mm	PK	Afrox
WD2820	F0001206	Parallel	8 mm	EA	Octo



A0004464

**Hose Crimper Clamps**

Stock Code	System Code	Type	Size	Uom	Brand
CR0041	A0005583	For Hose Clip	180 mm	EA	Crescent

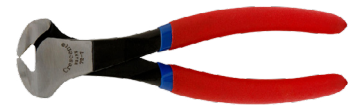

A0005583

**Lighters**

Stock Code	System Code	Type	Uom	Brand
WD1720	F0001129	Triple Flint Lighter	EA	Octo
WD1800	F0001135	Triple Flint Refill Only	EA	Octo
HR0020	F0000748	Triple Flint	EA	Harris
AX0300	F0000695	Triple Flint, with One Spare	EA	Afrox



F0001129



F0001135

**Keys**

Stock Code	System Code	Type	Uom	Brand
HR0015	F0000747	100515 Spindle	EA	Harris



F0000747

**Welders Tools**

Stock Code	System Code	Uom	Brand
HR0050	F0000754	EA	Harris
AX0310	F0000696	EA	Afrox
WD7230	F0001643	EA	Octo



F0000696



F0000754

**Fluxes**

Stock Code	System Code	Type	Size	Uom	Brand
WD5750	F0001509	Silver Solder	250 gm	EA	Matweld



F0001509

**Pickling Paste**

Stock Code	System Code	Type	Size	Uom	Brand
WD0150	F0000342	TSK Green	2 Kg	EA	Octo



F0000342



Temperature Crayons				
Stock Code	System Code	Temp Range	Uom	Brand
WD0900	F0001066	38°C	EA	Tempindic
WD0910	F0001067	52°C	EA	Tempindic
WD0920	F0001068	59°C	EA	Tempindic
WD0930	F0001069	66°C	EA	Tempindic
WD0940	F0001070	79°C	EA	Tempindic
WD0950	F0001071	93°C	EA	Tempindic
WD0960	F0001072	101°C	EA	Tempindic
WD0970	F0001073	107°C	EA	Tempindic
WD0980	F0001074	110°C	EA	Tempindic
WD0990	F0001075	121°C	EA	Tempindic
WD1000	F0001076	135°C	EA	Tempindic
WD1010	F0001077	149°C	EA	Tempindic
WD1020	F0001078	163°C	EA	Tempindic
WD1030	F0001079	177°C	EA	Tempindic
WD1040	F0001080	191°C	EA	Tempindic
WD1050	F0001081	204°C	EA	Tempindic
WD1060	F0001082	218°C	EA	Tempindic
WD1070	F0001083	232°C	EA	Tempindic
WD1080	F0001084	246°C	EA	Tempindic
WD1090	F0001085	253°C	EA	Tempindic
WD1100	F0001086	260°C	EA	Tempindic
WD1110	F0001087	274°C	EA	Tempindic
WD1120	F0001088	288°C	EA	Tempindic
WD1130	F0001089	302°C	EA	Tempindic
WD1140	F0001090	316°C	EA	Tempindic
WD1150	F0001091	343°C	EA	Tempindic
WD1160	F0001092	371°C	EA	Tempindic
WD1170	F0001093	399°C	EA	Tempindic



F0001066

WELDING, CUTTING AND BRAZING

Dissolve Purge Papers					
Stock Code	System Code	Type	Length	Uom	Brand
WD7210	F0001639	-	394.0 mm x 50.3 m	EA	Octo
WD7211	F0001640	-	787.0 mm x 50.3 m	EA	Octo
WD7212	F0001641	Tape	50 mm x 91.4 m	EA	Octo
WD7213	F0001642	Tape	25 mm x 91.4 m	EA	Octo







**Welding Helmets**

Stock Code	System Code	Type	Uom	Brand
WD0020	E0004951	Auto Darkening Econo	EA	Octo
WD0031	E0004953	Auto Darkening Weld & Grind	EA	Octo
WD0030	E0004952	Auto Darkening Weld & Grind, Deluxe	EA	Octo
WD0040	E0004954	Flip Front	EA	Octo
AX0350	E000095B	Flip Front	EA	Afrox



E0004951



E000095B



E0004953



E0004952



E0004954

**Welders Caps**

Stock Code	System Code	Colour	Uom	Brand
PE2500	E0002999	Various	EA	Sowers



E0002999

**Welding Lens**

Stock Code	System Code	Shade	Size	Uom
WD7000	F0001624	Clear	108 x 51 mm	EA
WD7010	F0001625	Clear	108 x 51 mm	EA
WD7020	F0001626	Clear	50 mm Round	EA
WD7090	F0001633	Clear	108 x 51 mm	EA
WD7030	F0001627	T5	50 mm Round	EA
WD7040	F0001628	T6	108 x 51 mm	EA
WD7050	F0001629	T7	108 x 51 mm	EA
WD7060	F0001630	T8	108 x 51 mm	EA
WD7070	F0001631	T9	108 x 51 mm	EA
WD7080	F0001632	T10	108 x 51 mm	EA
WD7100	F0001634	T11	108 x 51 mm	EA
WD7110	F0001635	T12	108 x 51 mm	EA
PE0065	E0002931	Clear	108 x 50 mm	EA
PE0067	E0002932	Shade 10	108 x 41 mm	EA



F0001624



F0001625



F0001633



F0001627



F0001626



F0001629

**Anti-Spatter Sprays**

Stock Code	System Code	Type	Size	Uom	Brand
WD0100	F0001000	Non-Silicone	400 ml	EA	Octo
WD0110	F0001001	Silicone	400 ml	EA	Octo
WD0120	F0001002	Silicone	500 ml	EA	Octo
CO0170	A0005442	Water Based	398 gm	EA	CRC

**Cold Zinc Galvanise Sprays**

Stock Code	System Code	Size	Uom	Brand
WD0130	A0015250	400 ml	EA	Octo
CO0060	A0005432	312 gm	EA	CRC

**Surface Cleaners**

Stock Code	System Code	Size	Uom	Brand
WD0180	F0001006	2 Kg	EA	Octo
WD0190	F0001007	20 Kg	EA	Octo

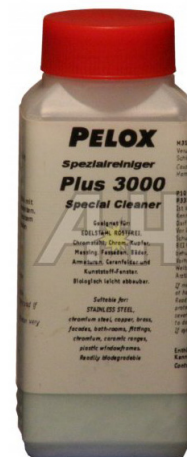

F0001006



### Welding Screens

\*Sizes can be Custom Made to any Specifications

Stock Code	System Code	Size	Type	Uom
WD0045	F0001902	2 m x 2 m	Yellow Welding Screen	EA
WD0046	F0000965	2 m x 3 m	Yellow Welding Screen	EA
WD0047	F0000966	3 m x 3 m	Yellow Welding Screen	EA
WD0048	F0000967	3 m x 1.5 m	Yellow Welding Screen	EA
WD0049	F0000968	1.8 m x 2.4 m	Yellow Welding Screen	EA
WD0050	F0000969	2 m x 2 m	Mobile Welding Screen Frame	EA
WD0051	F0000970	2 m x 3 m	Mobile Welding Screen Frame	EA

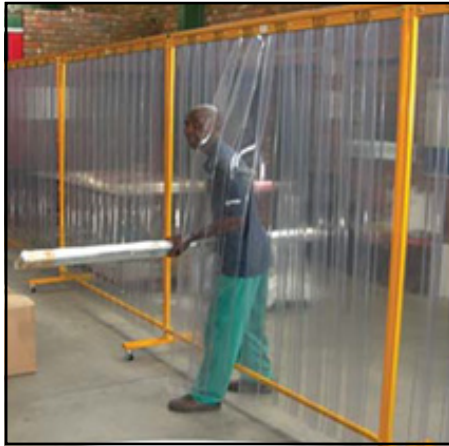

**Strip Curtains**

\*Sizes can be Custom Made to any Specifications

Stock Code	System Code	SIZE	TYPE	UOM
WD0066	D29	200 mm x 2 mm	Clear Strip	PM
WD0067	D50	300 mm x 3 mm	Clear Strip	PM
WD0058	D52	200 mm x 2 mm	Welding Blue Strip	PM
WD0059	D54	200 mm x 2 mm	Welding Bronze Strip	PM
WD0062	D53	200 mm x 2 mm	Yellow Strip	PM
WD0065	D52	200 mm x 2 mm	Green Strip	PM
WD0056	F0000971	200 mm x 2 mm	Blue Welding Strip Mobile Frame	PM
WD0057	F971	200 mm x 2 mm	Bronze Welding Strip Mobile Frame	PM



**Fire Blankets**

\*Sizes can be Custom Made to any Specifications

Stock Code	System Code	Size	Type	Uom
WD0079	F0000985	2 m x 2 m	Glass Fibre	EA
WD0086	F0000991	2 m x 3 m	Glass Fibre	EA
WD0087	F0000992	3 m x 3 m	Glass Fibre	EA
WD0088	F0000993	1 m x 50 m	Glass Fibre 0.62 mm	ROLL
WD0089	F0000994	1 m x 50 m	Glass Fibre 0.40 mm	ROLL
WD0081	F0000987	2 m x 2 m	Silicone Coated Sasol Spec.	EA
WD0082	F0000988	2 m x 3 m	Silicone Coated Sasol Spec.	EA
WD0083	F0000989	3 m x 3 m	Silicone Coated Sasol Spec.	EA
WD0080	F0000986	1 m x 50 m	Silicone Coated Sasol Spec.	ROLL
WD0091	F0000996	2 m x 2 m	Ceramic Fibre 1200 Degrees	EA
WD0092	F0000997	2 m x 3 m	Ceramic Fibre 1200 Degrees	EA
WD0090	F0000995	1 m x 30 m	Ceramic Fibre 1200 Degrees	ROLL
WD0098	F0003220	2 m x 2 m	Pre Ox Fibre Black	EA