

\*IMAGES ARE FOR DISPLAY PURPOSES ONLY

**Geared Head Lathe**

Stock Code	System Code	Centre Size	Swing	Motor	Volts	Uom
WE0300	G0000021	1000 mm	360 mm	5.5 kw	380 V	EA

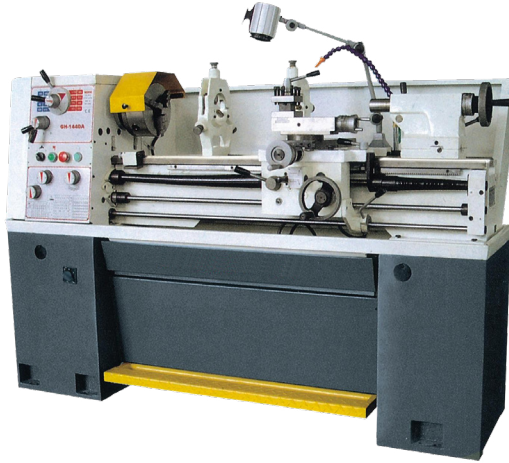

**Pedestal Drilling Machine**

Stock Code	System Code	Type	Drill	Spindle	Throat	Spindle	Motor	Volts	Uom
WE0200	A0031551	Belt Driven	20 mm	210-2580RPM	168 mm	85 mm	0.55 kw	220 V	EA
WE0205	A0016428	Belt Driven	25 mm	210-2500RPM	215 mm	82 mm	0.85 kw	380 V	EA



**Work Bench**

Stock Code	System Code	Type	Size	Uom	Brand
GD2481	A0007297	1500/12	1200 x 700 x 900mm	EA	Gedore
GD2482	A0007298	1500/15	1500 x 700 x 900mm	EA	Gedore
GD2483	A0007299	1500/20	2000 x 700 x 900 mm	EA	Gedore
GD2485	A0007300	Drawer Unit	-	EA	Gedore





**Wood Working Machines - Circular Saw 600 mm**

Sliding Table with Outrigger Support



JTS-600

System Code	Cross Cut Capacity	Motor	Blade	Depth Cut with Tilting Arbor	Volt
	mm	W	Ø	mm	
JTS-600	600	2600	250	80	230



JWBS-14

Rip Fence, Mitre Square and Re-Saw Guide



JPS-10TS

Cast Iron Table and Extensions

Wood Working Machines - Bandsaw					
System Code	Blade Size	Throat	Motor	Depth of Cut	Volt
		mm	W		
JWBS-14	2560 x 6/10/13	380	550	200	230

**Wood Working Machines - Circular Saw 760 mm**

System Code	Rip Capacity	Motor	Blade	Depth Cut	Volt
	mm	W	Ø	mm	
JPS-10TS	760	2600	250	79	230



JSS-16

Blower included and can be linked to the vacuum



G0000013

**Wood Working Machines - Scroll Saw**

System Code	Blade Size	Throat	Motor	Table	Volt
		mm	W		
JSS-16	380	400	Variable Speed	Aluminium Tilting	230

**Wood Working Machines - Bandsaw**

System Code	Blade	Table Size	Working Capacity		Spindle Speed	Motor	
		mm	W	H	RPM	kW	V
G0000013	2362 x 13 x 1	350 x 353	349	140	170, 290, 460, 780	0.3	230



JWP-12



16-32

Balanced Aluminium Drum

Wood Working Machines - Portable Thicknesser				
System Code	Width of Cut	Motor	Blade Thickness	Volt
	mm	W	mm	
JWP-12	310	1600	3	230

Wood Working Machines - Drum Sander			
System Code	Drum Width	Motor	Volt
	mm	W	
16-32	400	736	230
22-44	560	1300	230



JPT-260

Cast Iron Table



JSG-96

Cast Iron Tilting Table Dust Extraction

Wood Working Machines - Combination Planner/Thicknesser			
System Code	Thickness width x height	Motor	Volt
	mm	W	
JPT-260	252 x 225	1710	230
JPT-310	310 x 225	2200	230 or 380

Wood Working Machines - Belt and Disc Sander				
System Code	Disc Ø	Belt	Motor	Volt
	mm	mm	W	
JSG-96	230	150	500	230



JWP-160S

Extension Table Supports Included



BDS

Stand is Optional

Wood Working Machines - Thicknesser				
System Code	Cut Width x Thick	Motor	Blades	Volt
	mm	W	mm	
JWP-160S	400 x 200	2200	3x3 thick	230

Wood Working Machines - Belt and Disc Sander					
System Code	Disc Ø	Belt	No load speed	Motor	
	mm	mm	RPM	kW	V
BDS	300	150 x 1220	2850	0.75	230



G0003709



A0031322

**Wood Working Machines - Horizontal/Vertical Belt Sander**

System Code	Table Length	Table Width	Belt Length	Belt Width	Linear Speed	Motor	
	mm	mm	mm	mm	m/min	kW	V
G0003709	685	250	2260	150	1000	1.1	230
G0003710	685	250	2260	150	1000	1.1	380

**Bench Fly Presses**

System Code	Pressure	Throat Height	Throat Depth	Table
	ton	mm	mm	
A0031322	3	170	110	250 x 230
A0031323	5	170	250	320 x 230



A0031631

Four Position Anvil. Steel Rams and Pinions.

**Arbor Presses**

System Code	Pressure	Throat Height	Throat Depth	Base
	ton	mm	mm	
A0031631	1/2	112	90	100 x 240
A0031630	1	130	100	125 x 275
A0031632	2	215	150	170 x 430
A0031633	3	315	175	205 x 460
A0031629	5	715	220	250 x 680



G0000299

Plate & Bar Shears				
System Code	Max Plate	Max Flat	Max Round	Blade Length
	mm	mm	mm	mm
G0000299	4	70 x 5	10	120
G0000301	5	70 x 6	11	160
G0000302	6	70 x 7	13	200
G0000303	7	80 x 7	16	250
G0000300	4	70 x 6	13	300



P10

Punches			
System Code	Max Punch Ø	Throat Max Plate	Throat
	mm	mm	mm
P10	10	6	80
P12	12	8	120
P16	16	10	160

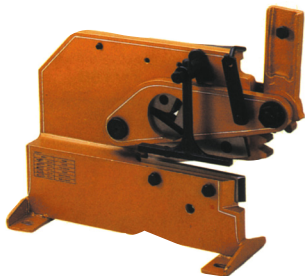

G0000311

Plate, Bar & Section Shears							
System Code	Max Plate	Max Round	Max Flat	Max Square	Max Angle	T'S	Blade Length
	mm	mm	mm			mm	mm
G0000311	8	16	100x10	-	40 x 6	40x60	200
G0000313	8	22	100x10	-	-	-	200



G0000298

Combined Shear Punches							
System Code	Max Plate	Max Flat	Max Round	Max Square	Max Punch Ø	Throat Max Plate	Throat
	mm	mm	mm	mm	mm	mm	mm
G0000298	6	70x7	13	11	10	6	80

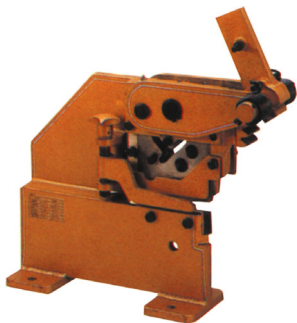

G0000312

Plate, Bar & Section Shears							
System Code	Max Plate	Max Round	Max Flat	Max Square	Max Angle	T'S	Blade Length
	mm	mm	mm			mm	mm
G0000312	8	20	80x12	18	50 x 6	50x6	175



CSC22

Concrete/Steel Cutter			
System Code	Max Round	Max Square	Max Flat
	mm	mm	mm
CSC22	22	20	30 x 10
CSC28	28	24	40 x 15

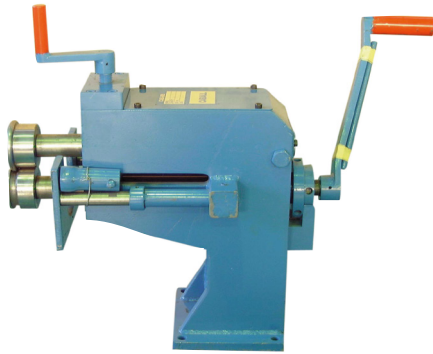

A0031325

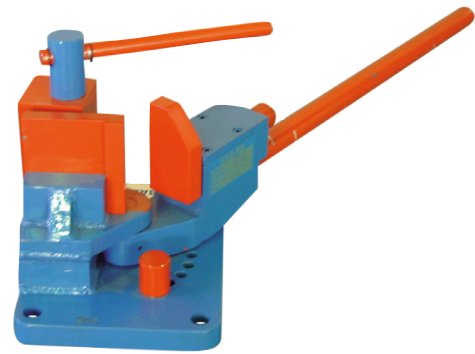

G0001049

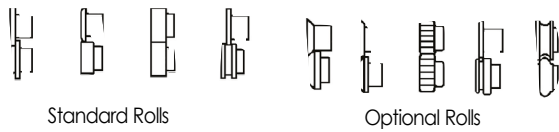

Standard Rolls

Optional Rolls

Jenny/Multi Roll			
System Code	Capacity	Roller Centre	Throat
	mm	mm	mm
A0031325	1.6	68	280

System Code	Capacity			Capacity		
	Cold			Hot		
	bar mm	Ø mm	sq mm	bar mm	Ø mm	bar mm
G0001049	100 x 6	18	16	100 x 8	25	20



UTB



G0006991

Manual Pipe Bender			
System Code	Pipe Bending Range	No. of Formers	Bend Angle
G0006991	10 - 25	7	≤180°

Universal Tube Benders				
System Code	Suitable for	Max Ø	Tube	Max. Bend Angle
		mm	mm	
G0000363	Round & Square	25.4	25.4	180°

Standard Dies				
System Code	Tube	Size	To Bend Tube	Min. Radii Possible
			mm	mm
G0001059	Square	13	12+12.7sq	59
G0001060	Square	16	15.9sq	80
G0001061	Square	20	19.1+19.6sq	93
G0001062	Square	26	25+25.4sq	115
G0001055	Round	13	12+12.7 Ø	48
G0001056	Round	20	19.5 Ø	70
G0001057	Round	22	21.4 Ø	70
G0001058	Round	26	25+25.4 Ø	89



A0027914

Hydraulic Pipe Benders					
System Code	Pipe Bending Range	No. of Formers	Bend Angle	Working Pressure	Max. Stroke
	mm			Mpa	mm
A0027914	1/2" - 2	6	≤180°	45	250
A0027915	1/2" - 3	8	≤180°	50	320



G0006998

Models SB38NC & SB50NC

NC Hydraulic Pipe Bending Machine			
System Code	Max. Diameter	Max. Bending Radius	Max. Bending Angle
	mm		
G0006998	38	300	190°
Max Mandrel Length		Oil Pump	Weight
mm		kW	kg
2000		5	1140
System Code	Max Diameter	Max Bending Radius	Max Bending Angle
	mm		
G0006999	50.8	450	190°
Max Mandrel Length		Oil Pump	Weight
mm		kW	kg
2000		7.5	1300



G000382

Models PK35F

Section and Pipe Bending Machine				
System Code	Max. Shaft Diameter	Max. section	Max Pipe Diameter	Roll Diameter
	mm	mm	mm	mm
G0000382	35	various	70 x 2	155
Working Speed	Motor		Size	Weight
	m/min	kW		v
4.5	1.5	380	750 x 1000 x 1400	400



G0000379

Models HPK80

Section and Pipe Bending Machine				
System Code	Max. Shaft Diameter	Max. Section	Max. Pipe Diameter	Roll Diameter
	mm	mm	mm	mm
G0000379	50	Various	100 x 2.5	245
Working Speed	Motor		Size	Weight
	m/min	kW		v
6	4	380	1450 x 1000 x 1400	1700

Available with optional NC Control System



G0000371



G0000139

Models HPK100

Section and Pipe Bending Machine				
System Code	Max. Shaft Diameter	Max. Section	Max. Pipe Diameter	Roll Diameter
	mm	mm	mm	mm
G0000371	75	various	125x2.5	315
Working Speed	Motor		Size	Weight
	m/min	kW	V	mm
7	75	380	2000 x 1450 x 1700	3650

Available with optional NC Control System

Box and Pan Folders					
System Code	Max Bending Capacity	Table Bar	Min. Return Bend with Angle	Max. Depth of Tray Formed	No & Width of Finger
	mm	mm	mm	mm	mm
G0000139	900 x 2	50 x 50 x 5	16	95	6x50, 4x75, 3x100
G0000137	1250 x 2	50 x 50 x 5	16	95	6x50, 5x75, 4x100, 2x80, 1x95
G0000138	2000 x 1.6	60 x 60 x 5	16	95	6x50, 4x75, 4x100, 4x150, 2x200

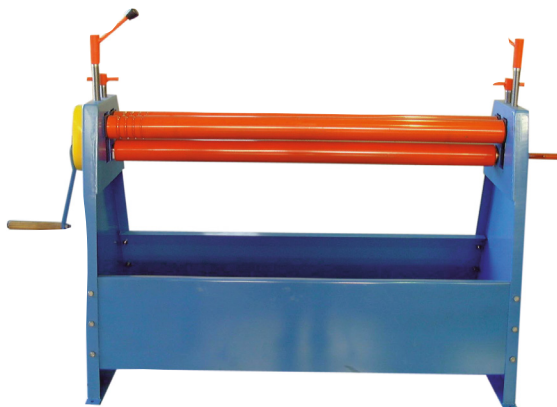

SR

Slip Rolls			
System Code	Length of Rolls	Max Plate	Min Roll Ø
	mm	mm	mm
SR	1270	1.6	75



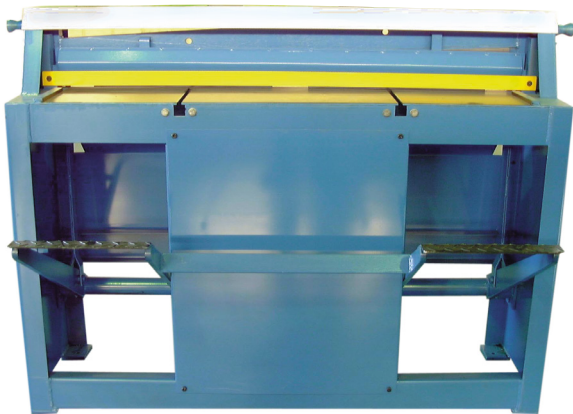

A0031324



G0000192

Mechanical down drive system. Mechanical back gauge  
Model Q11-4x2500

Guillotines					
System Code	Operation	Max. Sheet Width	Max. Sheet Thickness	Back Gauge Distance	Front Gauge Distance
		mm	mm	mm	mm
A0031324	Hand	1250	2	610	660
G0000186	Treadle	1250	1,6	610	660
G0000185	Motorised	1250	2	610	660

Hydraulic Guillotines						
System Code	Shearing Thickness	Shearing Width	Shearing Angle	Back Gauge Range	Table Height	Motor Code
	mm	mm		mm	mm	kW V
G0000192	4	2500	1°3'	500	800	5,5 380

Available with full CNC Control

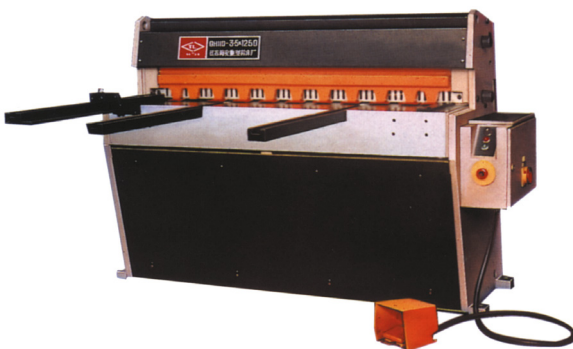

G0000187

Model QH11D

Motorised Guillotines						
System Code	Max Plate Width	Max Plate Thickness	Strokes	Back Gauge Distance	Front Support Arms	Motor
		mm				mm
G0000187	1250	3,5	10	0-650	1000	5,5 380

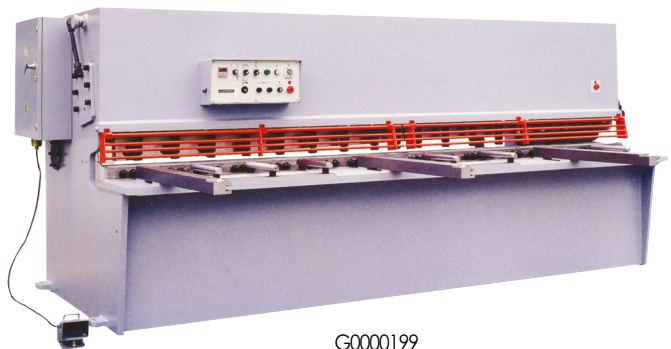

G0000199

Plate alignment by light beam. Mechanical back gauge.  
Premium quality hydraulics & electrics

Heavy Duty Hydraulic Swing Beam Guillotines					
System Code	Shearing Thickness	Shearing Width	Shearing Angle	Weight	Motor
	mm	mm		Kg	kW
G0000193	6	2500	1°3'	5200	7,5/380
G0000199	6	3200	1°3'	5900	7,5/380
G0000199	6	4000	1°3'	8600	7,5/380
G0000202	12	4000	1°3'	14600	18,5/380



G0000156



G0000250

Mechanically adjustable X & Y axes with digital display for stroke and back gauge adjustment. Premium quality hydraulics and electrics. Motorised RAM and back stop and 2 axis DRO

Models W11 2500x4, and W11 2500x6

Torque Shaft Synchronised Hydraulic Pressbrakes							
System Code	Nominal Pressure	Table Length	Throat Depth	Open Height	Ram Stroke	Motor	
	KN	mm	mm	mm	mm	kW	V
G0000156	400	2000	250	380	100	4	380
G0000158	630	2500	250	390	100	4	380
G0000142	1100	1100	410	420	150	75	380
G0000145	1600	1600	350	450	160	11	380
G0000147	1600	1600	410	450	160	11	380

Motorised Plate Rollin Machines - 3 Roller Symmetrical Structure				
System Code	Length of Rolls	Max. Plate Thickness	Min Rolling Ø	Motor
	mm	mm	mm	kW
G0000250	2500	4	300	4
G0000251	2500	6	380	5.5

Available with full CNC Control



G0000243



G0000217

Models W11 2X1200

Model 3RHS30-210 & 3RHS 25-280

Motorised Plate Rolling Machines. 3 Roller Asymmetrical Structure				
System Code	Length Of Rolls	Max Plate Thickness	Min Rolling Ø	Motor
	mm	mm	mm	kW
G0000243	1200	2	250	250

3 Roll Hydraulic Plate Rolling Machine					
System Code	Max. Plate Thickness	Motor	Working Speed	Size	Weight
	mm	kW	m/min		kg
G0000217	6	7.5	5	4400 x 1200 x 1300	5205
G0000213	13	11	5	4600 x 1400 x 1550	7720

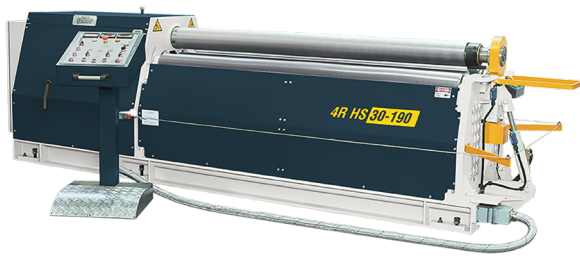

G0000222

Model 4RHS25-190 and 4RHS30-245

4 Roll Hydraulic Plate Rolling Machine					
System Code	Max. Plate Thickness	Motor		Working Speed	Weight
	mm	kW	V	m/min	kg
G0000225	6	5,5	380	1,5-6	4000
G0000222	8	7,5	380	1,5-6	6600



G0000289

Model Minicrop 45 with Punching, Shearing and Rectangular Notching Functions.

Hydraulic Iron Worker					
System Code	Punching Power	Flats Shear	Angle Iron Shear at Right Angles	Round Shear	Square Shear
	ton			mm	mm
G0000289	45	200 x 13 300 x 10	80 x 80 x 8 100 x 100 x 10 slight distortion	30	20
Notching		Punching Capacity		Motor	
Sheet Metal	Angle Iron	mm	Throat	kW	V
7	60	27Ø x 13 thick	175	2.2	380

**Optional Extras:** Channel and I beam shear, pressbrake, tube notcher, oversize punching attachment (Ø100X4)



G0000288

Model Microcrop 36 with Punching and Shearing Functions.

Hydraulic Iron Worker					
System Code	Punching Power	Flats Shear	Angle Iron Shear		Round Shear
	ton		at 90°	at 45°	mm
G0000288	36	200 x 13	80 x 80 x 8	50 x 50 x 6	20
Square shear	Punching Power	Throat	Motor		
mm	ton	mm	kW	V	
20	27Ø x 10 thick	170	2.2	380	

**Optional Extras:** Notching steel 8 mm. Notching angle Iron 60 mm. Channel and I-beam shear, Triangular notcher, Tube notcher, Pressbrake, Blades to increase round shear to 35 mm Ø and square to 30 mm square. Oversized Punching attachment (Ø 36 x 8).



G0000293

Model Hydracrop 55/110A with Punching, Shearing and Rectangular Notching Functions

Hydraulic Iron Worker					
System Code	Punching Power	Flats Shear	Angle Iron Shear At Right Angles	Round Shear	Square Shear
	ton			mm	mm
G0000293	55	300 x 15	120 x 120 x 10	40	40
Notching		Punching Capacity		Motor	
Sheet Metal	Angle Iron	mm	Throat	kW	V
10	12	40Ø x 10	250	3	380

**Optional Extras:** Tube notcher, pressbrake, Special blades to increase shearing and cropping capacity.



BENDI60/380

Mode bendicrop 60 with bending, notching, punching and shearing functions.

Hydraulic Iron Worker					
System Code	Punching Power	Flats Shear	Angle Iron Shear at Right Angles	Round Shear	
	ton			mm	mm
BENDI60/380	60	356 x 10	120 x 120 x 10	45	
Angle Iron Shear at Right Angles	Throat	Notching Capacity	Bending Throat	Strokes/Min	
		mm		kW	V
127 x 127 x 10	254	100 x 100 x 10	152 x 10	32	

**Optional Extras:** Tube notcher, pressbrake, special blades to increase shearing and cropping capacity.



G0000287

Model hydracrop 110/180s with punching, shearing and rectangular notching functions

Hydraulic Iron Worker					
System Code	Punching power	Flats shear	Angle iron shear at right angles	Round shear	
	ton			mm	mm
G0000287	110	600 x 15 400 x 20	152 x 152 x 13 70 x 70 x 7	50	
Notching		Punching Capacity		Motor	
sheet metal	angle iron	mm	throat	kW	V
13	16	400 x 20	300	5	380

**Optional Extras:** Tube notcher, pressbrake, special blades to increase shearing and cropping capacity.



BENDI85/SD

Mode bendicrop 85 SD with bending, notching, punching and shearing functions.

Hydraulic Iron Worker					
System Code	Punching Power	Flats Shear	Angle Iron Shear at Right Angles	Round Shear	
	ton			mm	mm
BENDI85/SD	85	457 x 14	127 x 127 x 14	40	
Angle Iron Shear at Right Angles	Throat	Notching Capacity	Bending Throat	Strokes/Min	
		mm		kW	V
127 x 127 x 10	508	90 x 50 x 14	197 x 14	40	

**Optional Extras:** Tube notcher, pressbrake, special blades to increase shearing and cropping capacity.



G0000295

Model Hydracrop 110/SD with Semi-Paxy CNC table and Fagor controller.

Hydraulic Iron Worker					
System Code	Punching Power	Flats Shear	Angle Iron Shear at Right Angles	Round Shear	
	ton			mm	mm
G0000295	110	600 x 15 400 x 20	152 x 152 x 13 160 x 160 x 16	50	
Notching		Punching Capacity		Motor	
Sheet Metal	Angle Iron	mm	Throat	kW	V
10	100	400 x 20	500	5	380

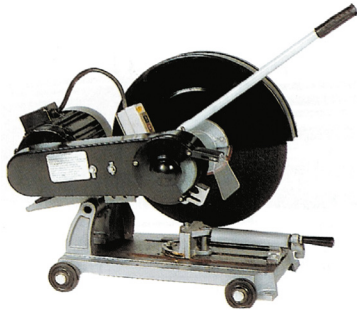

G0010703



A0030184

Abrasive Cut Off Machines								
System Code	Maximum Cutting Capacity mm					Wheel	Motor	
	Ø	Sq 90°	Sq 45°	Rect 90°	Rect 45°	Ø mm	kW	V
G0010703	40	70	60	55 x 95	55 x 65	405	2.2	220
A0031570	40	70	60	55 x 95	55 x 65	405	3.7	380

**NOTE:** Supplied without cut off wheel.

High speed steel circular saw blades

Circular Cut Off Machines				
System Code	Blade Ø	Vice Opening	RPM	Motor
	mm	mm		
A0030184	225/250	105	40	220V
A0030185	225/250	105	40 + 80	380V



G0000339

Cutting capacity mm							
90°				45°			
●	○	□	▭	●	○	□	▭
30	70	65	100 x 45	25	60	55	60 x 50

Mitre cut: 0-45°R

Swivel head 45° left and right.

Heavy Duty Abrasive Cut Off Machines								
System Code	Cutting Capacity mm							
	90°				45°			
	●	○	□	▭	●	○	□	▭
G0000339	70	135	115 x 115	120 x 115	50	115	80 x 80	120 x 80
G0000340	90	165	135 x 135	165 x 135	70	130	100 x 100	165 x 135

Wheel Ø	Motor	
mm	kW	V
300/350/400	4	380
400/500	7.5	380

**NOTE:** Supplied with standard equipment; chain vice, 2 x table extensions.

Circular Cut Off Machines								
System Code	Blade Ø		Vice Opening		RPM	Motor		
	mm		mm					
A0030186	300/315		120		41	220V		
A0030187	300/315		120		41 + 82	380V		
Cutting Capacity mm								
90°				45°				
●	○	□	▭	●	○	□	▭	
45	95	82	110x 70	35	90	80	85 x 70	

Mitre cut: 0-45° L & R

System Code	Blade Ø		Vice Opening		RPM	Motor		
	mm		mm					
A0030188	300/350		170		22 + 44 + 88	380V		
Cutting Capacity mm								
90°				45°				
●	○	□	▭	●	○	□	▭	
85	120	105	160x 90	75	100	85	85 x 70	

Mitre cut: 0-90° R & 0-45° L

**NOTE:** The above cut off machines are supplied without the machine stand. Machine stands are an optional extra. All saws supplied with the smaller diameter blade.



A0030180

Fully automatic model. With programable cutting cycle. Pneumatically operated

Fully and Semi Automatic Circular Cut Off Machines								
System Code	Blade Ø		Vice Opening		RPM	Motor		
	mm		mm			kW	V	
A0030180	350		170		22 + 44 + 88	2.4	380	
Cutting capacity mm								
90°				45°				
●	○	□	▭	●	○	□	▭	
60	120	105	160x 90	60	100	85	85 x 70	



A0034831

Metal cutting, Horizontal / Vertical Model RF128

Band Saw Machine 128Ø Capacity								
System Code	Sawing Capacity mm		Blade Speeds		Blade Size		Motor	
	●	▭	m/min		mm		kW	V
A0034831	128	115 x 150	24	36 67	1635 x 13		0.2	220



G0000123

Metal cutting, 45° swivel head Model RF712N

Swivel Head Band Saw Machines 180Ø Capacity								
System Code	Sawing Capacity mm		Blade Speeds		Blade Size		Motor	
	●	▭	m/min		mm		kW	V
G0000123	180	180 x 215	23	34 50 65	2362 x 19		0.75	220
G0000124	180	180 x 215	23	34 50 65	2362 x 19		0.75	380



G000095

Metal cutting, Horizontal Model RF812N

Band Saw Machines 200Ø Capacity						
System Code	Sawing Capacity mm		Blade Speeds m/min	Blade Size mm	Motor	
	●	■			kW	V
G000095	200	305 x 178	23 34 50 65	2362 x 19	0.75	220
G000094	200	305 x 178	23 34 50 65	2362 x 19	0.75	380



G0000100

Metal cutting, Horizontal Model RF1018S

Band Saw Machines 254Ø Capacity						
System Code	Sawing Capacity mm		Blade Speeds m/min	Blade Size mm	Motor	
	●	■			kW	V
G0000100	254	457 x 127	29 50 73 96	3280 x 27	1.5	380

Metal cutting, Horizontal Model RF912B

Band Saw Machines 230Ø Capacity						
System Code	Sawing Capacity mm		Blade Speeds m/min	Blade Size mm	Motor	
	●	■			kW	V
G0000098	230	127 x 300	25 41 61 82	2655 x 27	1	380



BSM254/ 380

Metal cutting, Horizontal semi-automatic with two way-swivel head and variable speed motor Model RF-250NA

Swivel Head Band Saw Machines 254Ø Capacity									
System Code	Sawing Capacity mm						Blade Size	Motor	
	0° 45° 60°							kW	V
	●	■	●	■	●	■	Size		
BSM254/ 380	254	79 x 458	254	254 x 280	204	127 x 200	3353 x 27	1.5	380



SABSM300/380

Horizontal metal cutting, bandsaw with hydraulic vice Model RF300



CBSM250/380

Horizontal metal cutting, Manual operation Model MH1016JA

Double Column Semi Automatic 300Ø Capacity							
System Code	Sawing Capacity mm			Blade	Motor		Weight
	0°			Size	kW	V	kg
	●	■	▬	mm			
A0030191	300	300x500	300	300	3	380	760

Band Saw Machines 250Ø Capacity							
System Code	Sawing Capacity			Blade	Blade	Motor	
	mm			Speeds	Size	kW	V
	●	■	▬	M/min	mm		
G0000109	250	230	230 x 400	19 31 48 78	3353 x 25	1.5	380



CBSM200/220

Horizontal metal cutting, Manual operation Model MH812LC



CSABSM250S/380

Horizontal metal cutting, Swivel bed Model SH460M

Band Saw Machines 200Ø Capacity							
System Code	Sawing Capacity			Blade	Blade	Motor	
	mm			Speeds	Size	kW	V
	●	■	▬	M/min	mm		
G0000107	200	180	180 x 330	19 29 47 79	2720 x 25	0.75	220
G0000108	200	180	180 x 330	19 29 47 79	2720 x 25	0.75	380

Semi Automatic Band Saw Machines 250Ø Capacity							
System Code	Sawing Capacity			Blade	Blade	Motor	
	mm			Speeds	Size	kW	V
	●	■	▬	M/min	mm		
G0000113	250	230	230 x 460	19 31 48 78	3505 x 25	1.5	380





G0000104

Metal cutting, motorised roller feeding system, hydraulic clamping, automatic positioning. Model SH-250R

Automatic Band Saw Machines 250Ø Capacity							
System Code	Sawing Capacity			Blade	Blade	Motor	
	mm			Speeds	Size	kW	V
	●	■	▬	M/min	mm		
G0000104	250	230	230x250	19 31 48 78	3350x27	1.5	380



G0000105

Horizontal metal cutting, Swivel head, manual operation. MH500M

Band Saw Machines 330Ø Capacity for Structural Material							
System Code	Sawing Capacity			Blade	Blade	Motor	
	mm			Speeds	Size	kW	V
	●	■	▬	M/min	mm		
G0000105	330	280	280x460	24 38 60 105	4150x25	1.5	380



G0000111

Horizontal metal cutting. Automatic feed of material and cut off after initial set up and programming. Hydraulic blade tensioning. Power driven blade brush. Hydraulic shuttle vice. Models AH-250 & AH-300H Supplied complete with chip conveyor.

Automatic Band Saw Machines 250Ø Capacity Heavy-Duty Production - Cutting							
System Code	Sawing Capacity			Blade	Blade	Motor	
	mm			Speeds	Size	kW	V
	●	■	▬	M/min	mm		
G0000111	250	250	280 x 250	23-67	3505x27	2.2	380
G0000112	300	300	355 x 300	23-67	3820x34	3.75	380



G0000115

With chip conveyor. Hydraulic blade tensioning. Tungsten carbide blade guide. Model SH-5542

Twin Column Semi Automatic Heavy-Duty Band Saw Machine 420Ø Capacity							
System Code	Sawing Capacity			Blade	Blade	Motor	
	mm			Speeds	Size	kW	V
	●	■	▬	M/min	mm		
G0000115	420	420	460x420	20-100	5300 x 41	5.5	380

Standard accessories: Blade breakage detector, work light, complete coolant system, full stroke vice.

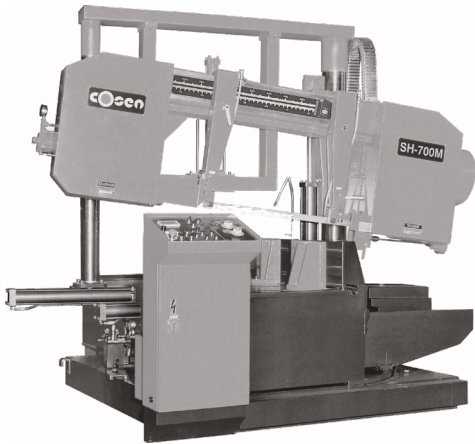

G0000116

Model SH-700M

Semi Automatic Dual Column Frame Swivel Miter Cutting Band Saw 500Ø Capacity							
System Code	Sawing Capacity			Blade	Blade	Motor	
	mm			Speeds	Size	kW	V
	●	■	▬	M/min	mm		
G0000116	500	500	400x700	25-95	5450-141	5,6	380



G0004436

Model SH-500M

Semi-Automatic Swivel Head Mitering Bandsaw 330Ø Capacity							
System Code							
G0004436							
Sawing Capacitymm						Blade	Weight
0° 45°						Size	kW
●	■	▬	●	■	▬	mm	Kg
330	280x500	290	280x280	220	280x200	4150X27	990
Motor				Blade			
kW		V		Speeds			
2.25		380		23,36,51,76			



G0000103

Model C-325NC  
Supplied with 2 meter roller table

CNC Automatic Bandsaw with Shuttle Vice for Mass Production 325Ø Capacity							
System Code	Sawing Capacity			Blade	Blade	Motor	
	mm			Speeds	Size	kW	V
	●	■	▬	M/min	mm		
G0000103	325	325	380x325	20-100	3820 x 34	3,75	380
Weight				Foot print			
kg				mm			
1800				2045 x 2015 x 1345			



KTC-150SP/380

For Mass Production, Precision Cutting

High Speed Circular Sawing Machine						
System Code	Sawing Capacity		Blade	Blade	Motor	
	mm		Speeds	Size	kW	V
	●	■	M/min	mm		
KTC-150SP/380	40-150	110	10-160	460 X 2,7 T	15	380



A0030191

Super TRAD 301 SO Digit



G0000130

Metal cutting, manual operation. Model VBS

Semi-Automatic Bandsaw 258Ø Capacity								
System Code	Sawing Capacity			Blade	Blade	Motor		Machine Weight
	mm			Speeds	Size	kW	V	kg
	●	■	▬	M/min	mm			
A0030191	255	250	300 x 200	33/66	2750 x 27	1.4	380	510

Vertical Band Saw Machines							
System Code	Throat Depth	Max Work Height	Table Size	Blade Speed	Blade Size	Motor	
	mm	mm	mm	m/mm	mm	kW	V
G0000130	356	205	500 x 600	20/80	2900 x 16	0.75	380
G0000131	396	255	550 x 600	20/80, 250/1000	3140 x 16	1.5	380
G0000134	508	305	600 x 560	65/555, 390/3280	3975 x 25	1.5	380



G0000127

Metal cutting, manual operation. Model KB



G0000126

With blade welder, blade grinder and blade tension indicator Model VBS3612

Vertical Band Saw Machines							
System Code	Throat Depth	Max Work Height	Table Size	Blade Speed	Blade Size	Motor	
	mm	mm	mm	m/mim	mm	kW	V
G0000127	310	175	500 x 400	20-90	2520 x 3-16	0.4	380
G0000129	355	230	500 x 400	20-90	2840 x 3-16	0.75	380
G0000133	455	255	600 x 500	25-115	3490 x 3-16	0.75	380

Vertical Band Saw Machines with Auto Power Feed Table							
System Code	Throat Depth	Max Work Height	Table Size	Blade Length	Blade Speed	Motor	
	mm	mm	mm	m/mim	m/mim	kW	V
G0000126	915	305	700 x 600 700 x 450	5040	15-1500	2.2	380

Cutsmart™ Technology



**Green.** The machine is working correctly within its safe operating parameter. By working within this zone you will gain longer life from your machine and your cutters.

**Orange.** As the indicator turns to orange this means that you are putting too much pressure on the machine. At this point you should release the pressure to bring the indicator back to the green zone. Maintaining this amount of pressure could cause additional wear to both its internal parts and your cutter.

**Red.** If the pressure on the machine is increased too far, the indicator will eventually turn from orange to red. Upon reaching this, the motor will cut-off to prevent any further damage. The machine will be held in this state for 5 seconds



A0030120

Element 30					
System Code	Max. Ø Hole Cutting Capacity	RPM	Spindle	Weight	Magnetic Adhesion
	mm			Kg	Kgs
A0030120	32 x 35 deep	600	19.05	10	850



ELEMENT40

Element 40					
System Code	Max. Ø Broach Only	RPM	Spindle	Weight	Magnetic Adhesion
	mm			Kg	Kgs
A0030122	40 x 50 deep	300/600	19.05	12.2	850



A0030124

Element 50						
System Code	Max. Ø Broach Only	Max. Drill	RPM	Spindle	Weight	Magnetic Adhesion
	mm				Kg	Kgs
A0030124	50	23	250/450	MT2/19.05	13	1850

### 3 Arm

Choose an arm that will meet your weight and reach requirements.



A0030128

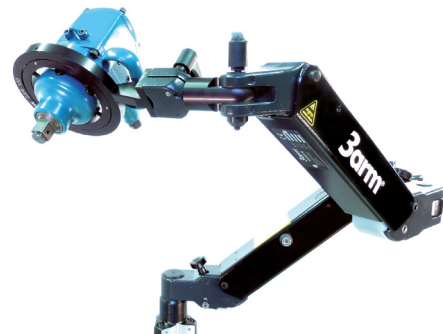

Easy, versatile and accurate tapping. Works on the parallelogram system which produces perfectly vertical threaded holes. Hand-feed ensures no oversized threads.

Element 75					
System Code	Max. Ø Broach Only	RPM	Spindle	Weight	Magnetic Adhesion
	mm			Kg	Kgs
A0030128	65 X 50	160/640	19.05	19.8	1200



A0030118



G0000449

Pivot Arm Threading Machines				
System Code	Threading Capacity	Speed Range	Pneumatic Motor	
	mm		Power Air	Consumption
G0000449	M2-M24	90-1050 RPM	730W	700L/min
Minimum Radius: 120 mm		Maximum Radius: 1100mm		

Seven quick change modules are available to adapt the motor in order to accommodate a range of speeds and torques for tapping different sizes from M2- M24.

Element 100					
System Code	Max. Ø Broach only	RPM	Spindle	Weight	Magnetic Adhesion
	mm			Kg	Kgs
A0030118	100 X100	40-600	MT3/19.05	26	3000

Geared Tapping Modules					
System Code	Max Thread Steel	Max Thread Steel	Max Thread	Max RPM	Collet
	>HRC22	<HRC22	Aluminium		
405G0000	M6	M6	M6	1000	TZ12
405F0000	M6	M8	M8	725	TZ12
405E0000	M8	M10	M10	525	TZ12
405D0000	M12	M14	M14	250	TZ12
405C0000	M16	M18	M18	160	TZ24
405A0000	M20	M22	M22	80	TZ24



BDM13

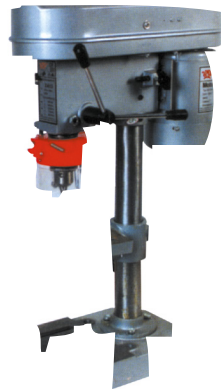

BDM16

Belt Drive

Bench Drilling Machines						
System Code	Drilling Capacity	Spindle Speed	Throat	Distance Spindle To Base	Spindle Travel	V
	mm	RPM	mm			
BDM13/220	13	600-2600	103	250	50	220
G0000343	16	270-2600	163	610	70	220



G0000358

Belt Drive

Bench Drilling Machines							
System Code	Drilling Capacity	Spindle Speed	Throat	Spindle Taper	Spindle Travel	Motor	
	mm	RPM	mm		mm	kW	V
G0000358	20	210-2580	168	MT2	85	0.55	220
G0000359	20	210-2580	168	MT2	85	0.55	380



A0037527

Geared Head

Bench Drilling Machines						
System Code	Drilling Capacity	Spindle Speed	Throat	Spindle Taper	Spindle Travel	Motor
	mm	RPM	mm		mm	kW
A0037527	25	100-2900	225	3MT	150	0.55 380



A0031551

Belt Drive

Pedestal Drilling Machines							
System Code	Drilling Capacity	Spindle Speed	Throat	Spindle Taper	Spindle Travel	Motor	
	mm	RPM	mm		mm	kW	V
A0031551	20	210-2580	168	2MT	85	0.55	220
A0031552	20	210-2580	168	2MT	85	0.55	380
A0031553	25	210-2500	215	3MT	82	0.75	220
A0016428	25	210-2500	215	3MT	82	0.85	380

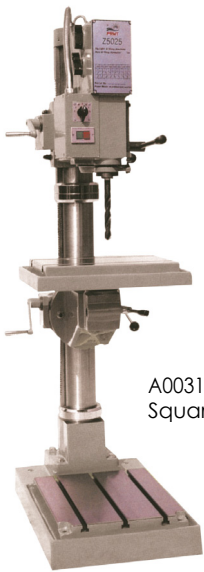

A0031549  
Square Table



A0031556  
Round Table



G0000342

Geared Head

Automatic feed, geared head

Pedestal Drilling Machines							
System Code	Drilling Capacity	Spindle Speed	Throat	Spindle Taper	Spindle Travel	Motor	
	mm	RPM	mm		mm	kW	V
A0031549	25	100-2900	315	3MT	150	0.75	380
A0031556	25	100-2900	225	3MT	150	0.75	380

Pedestal Drilling Machine							
System Code	Drilling Capacity	Spindle Speed	Throat	Spindle Taper	Spindle Travel	Motor	
	mm	RPM	mm		mm	kW	V
G0000342	28	70-3000	320	MT3	150	0.9/1.2	380



G0000342

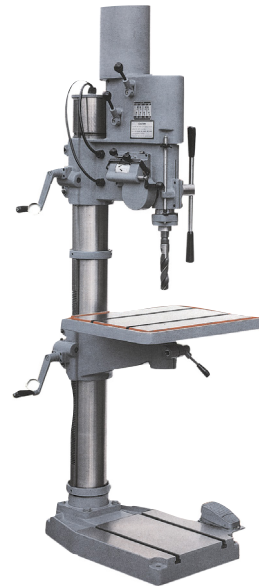

G0000323

Geared Head

Automatic feed, geared head, tapping facility.

Pedestal Drilling Machines							
System Code	Drilling Capacity	Spindle Speed	Throat	Spindle Taper	Spindle Travel	Motor	
	mm	RPM	mm		mm	kW	V
G0000342	25	105-2900	255	3MT	135	0.65/0.95	380

Cyclematic Pedestal Drilling Machine							
System Code	Drilling Capacity	Spindle Speed	Throat	Spindle Taper	Spindle Travel	Motor	
	mm	RPM	mm		mm	kW	V
G0000323	35	80-950	300	MT4	168	1.5	380



G0000346

Geared head with coolant, tapping mechanism and automatic feed.

Heavy-Duty Pedestal Drilling Machines							
System Code	Drilling Capacity	Spindle Speed	Throat	Spindle Taper	Spindle Travel	Motor	
	mm	RPM	mm			mm	kW
G0000346	35	70-2600	330	4MT	150	2.2	380
G0000348	40	42-2050	360	4MT	180	2.8	380



G0003704

Z Axis Power Feed. Model RF-500S

Heavy-Duty Pedestal Drilling Machine							
System Code	Drilling Capacity	Spindle Taper	Spindle Speed	Throat	Distance Spindle to Table		
	mm		RPM		mm	mm	
G0003704	50	M33	60-1810	340	713.5		
Z axis feed	Spindle Travel	spindle taper	Table Working Surface		Throat	Motor	
			mm/Rev	mm		RPM	mm
0.1/0.2/0.3/.04	200	MT4	600x600	340	2.2	380	

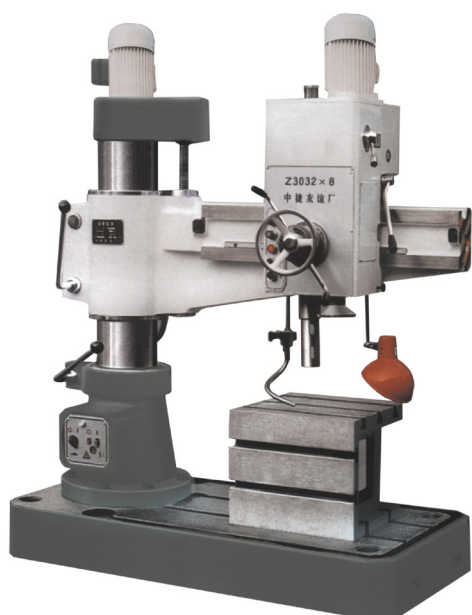

A0031561

Model Z3032x8

Radial Arm Drilling Machines						
System Code	Drilling Capacity	Spindle Speed	Throat mm		Distance Spindle to Table	
	mm	RPM	min	max	min	max
A0031561	32	75-1220	320	820	240	900
Vertical Arm Length		Spindle Travel	Spindle Taper	Motor		Weight
mm	mm			kW	V	
820		150	4MT	1.5	380	380





G0000349

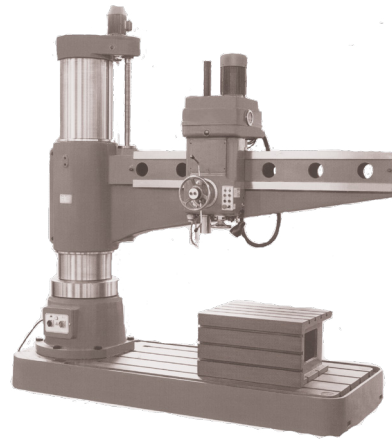

G0000354

Models Z3032x10/1 & Z3040X13/2 & Z3050x16

Model Z3080X13/2

Radial Arm Drilling Machines						
System Code	Drilling Capacity	Spindle Speed	Throat Mm		Distance Spindle to Table	
	mm	RPM	min	max	min	max
G0000349	32	75-1220	320	820	240	900
Vertical Arm Length	Spindle Travel	Spindle Taper	Motor		Weight	
mm	mm		kW	V	kg	
1100	150	4MT	1.5	380	1200	

Radial Arm Drilling Machines					
System Code	Drilling Capacity	Spindle Speed	Throat mm		
	mm	RPM	min	max	
G0000354	63	20-1600	400	1600	
Vertical Arm Length	Spindle Travel	Spindle Taper	Motor		Weight
mm	mm		kW	V	kg
2000	400	5MT	5.5	380	7000

System Code	Drilling Capacity	Spindle Speed	Throat mm		
	mm	RPM	min	max	
G0000350	40	32-2500	250	1000	
Vertical Arm Length	Spindle Travel	Spindle Taper	Motor		Weight
mm	mm		kW	V	kg
2000	280	4MT	2.2	380	1600



G0000326

Model RF 25

System Code	Drilling Capacity	Spindle Speed	Throat mm		Distance Spindle to Table	
	mm	RPM	min	max	min	max
G0000352	50	25-2000	350	1600	320	1220
Vertical Arm Length	Spindle Travel	Spindle Taper	Motor		Weight	
mm	mm		kW	V	kg	
1600	315	5MT	4.0	380	3500	

System Code	Drilling Capacity Steel	Spindle Speed	Face Milling Capacity		
	mm	RPM	steel	cast iron	
G0000326	25	R8	25	76	
G0000324	25	3MT	25	76	
G0000325	25	3MT	25	76	
End Milling Capacity		Table	Table Travel	Motor	
steel	cast iron			kW	V
16	25	585 x 190	340	.55	220
16	25	585 x 190	340	.55	220
16	25	585 x 190	340	.55	380

Supplied without stand.



G0000068

Model RF 31

Drilling / Milling Machines					
System Code	Drilling Capacity Steel		Spindle Taper	Face Milling Capacity	
	mm			steel	cast iron
G0000068	32		R8	32	76
G0000070	32		R8	32	76
A0031550	32		3MT	32	76
End Milling Capacity		Table	Table Travel	Motor	
Steel	Cast Iron			kW	V
20	32	730 x 210	430	1.1	380
20	32	730 x 210	430	1.1	380
20	32	730 x 210	430	1.1	380

Supplied without stand.



A0031550

Model RF 400 HC

Pedestal Drilling / Milling Machine					
System Code	Drilling Capacity Steel		Spindle Taper	Face Milling Capacity	
	mm			Steel	Cast Iron
A0031550	32		3MT	32	76
End Milling Capacity		Table	Table Travel	Motor	
steel	cast iron			kW	V
20	32	585 x 190	340	1.1	380



G0000068

Model RF 40

Geared Head Drilling / Milling Machines					
System Code	Drilling Capacity Steel		Spindle Taper	Face Milling Capacity	
	mm			Steel	Cast Iron
G0000068	32		R8	32	76
G0000070	32		R8	32	76
End milling capacity		Table	Table Travel	Motor	
Steel	Cast Iron			kW	V
20	32	730 x 210	500	0.75	220
20	32	730 x 210	500	0.75	380

Supplied without stand.



G0000072

Model RF 40 CPF

Geared Head Pedestal Drilling / Milling Machines					
System Code	Drilling Capacity Steel		Spindle Taper	Face Milling Capacity	
	mm			steel	cast iron
G0000072	32		R8	32	76
End Milling Capacity		Table	Table Travel	Motor	
Steel	Cast Iron			kW	V
20	32	585 x 190	320	0.75	380



A0031352

Double Ended



A0031550

Model FC50N. Automatic

Bench Grinders					
System Code	Wheel Size	Speed	Motor		Weight
	mm	RPM	Kw	V	Kg
A0031352	150 x 20 x 12	2950	0.2	220	8
A0031351	200 x 20 x 16	2950	0.35	220	15
A0031334	200 x 20 x 16	2950	0.35	380	15
A0031358	300 x 40 x 75	1500	1.5	380	75

BG300/380 supplied with pedestal

Universal Drill Sharpening Machines			
System Code	Drill Sharpening Capacity	Point Angles	End Mill Face Grinding Capacity Flutes
	mm		
A0031550	2.5 - 50	40° +180°	2 3 6 12
Grinding wheel	Point thinning wheel	Motor	
		kW	V
180 x 32 x 31.75	165 x 21 x 31.75	.75	380

**Optional Extras:** Coolant system, diamond and CBN wheels, work light, radius relief attachment for radius relief and end mill-face sharpening, wheel balancer, cam for Light Handing drills and cam for 3 flute drill grinding



G0002313

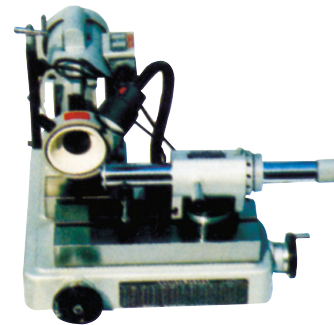

G0000502

Precision Drill Point Sharpening Machines				
System Code	Drill Sharpening Capacity	Point Angles	Motor	
	mm		Kw	V
G0002313	2.5 - 13	118° - 135°	0.18	220
G0002316	3 - 20	118° - 135°	0.18	220

Air Bearing Tool & Cutter Grinding						
System Code	Max Tool Shank	Max Tool Cutter	Max Tool Length	Collet Type	Air Bearing Stroke	Motor
	ø mm	ø mm	mm		mm	Kw
G0000502	50	220	220	5C	250	0.25 220



G0002323

Optional Accessories 5C Collets Extra	
System Code	Description
G0001370	Radius grinding attachment
G0001369	Drill sharpening attachment
G0001376	Tap sharpening attachment
G0001371	Sleeve 2MT

End Mill Sharpening Machines				
System Code	Drill Sharpening Capacity	Point Angles	Motor	
	mm		Kw	V
G0002323	4 - 13	118° - 135°	0.18	220
G0002322	12 - 25	118° - 135°	0.18	220

Optional Accessories 5C Collets Extra	
System Code	Description
G0001373	Sleeve 3MT
G0001372	Sleeve 32mm ø
G0001374	Sleeve 40mm ø
G0001375	Sleeve 50mm ø

WORKSHOP EQUIPMENT

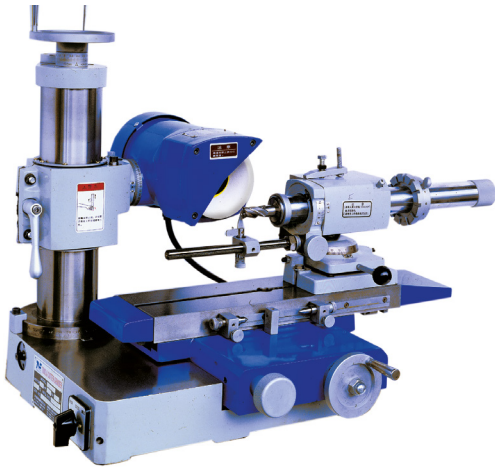

G0000502

Model CT610. Air Bearing System.



G0001448

For sharpening brazed carbide Tipped turning tools. Supplied with diamond grinding wheel.

Universal Tool and Cutter Grinders					
System Code	Distance Between Centres	Swing over table	Collets Ø		Parallel sleeves
	mm	mm	mm		Ø mm
G0000502	250	205	6	8 10 12 16 20 25	32 11/4
G0000504	250	205	6	8 10 12 16 20 25	32 11/4
Morse taper adaptor	Cap wheel	Dish wheel	Motor		
	Ø mm	Ø mm	kW	V	
2MT 3MT	127	152	0.25	32 11/4	
2MT 3MT	127	152	0.25	32 11/4	

Lathe Tool Grinders					
System Code	Grinding Wheel	Table Vertical Tilt	Table Angle Block	Motor	
	mm			kW	V
G0001448	125 x 16 x25	20°	70°	0.25	220

Optional Extras	
Stock Code	Description
C1SG	Sleeve 3MT
C1RG	Sleeve 32mm Ø
	Sleeve 40mm Ø
	Sleeve 50mm Ø



G0000643

Model GSG612B. Hand Operated.

Surface Grinding Machines Bench Type				
System Code	Table Size	Table Travel mm		Wheel Size
	mm	x	y	mm
G0000643	305 x 152	320	170	180 x 13 x 31.5
G0000645	305 x 152	320	170	180 x 13 x 31.5
Max Distance Spindle to Table			Motor	
mm			kW	V
280			0.55	220
280			0.55	380

Optional extras: Floor stand Cabinet, Magnetic Chuck, Diamond Wheel Dresser, Wheel Balancing Stand.



G0000547

X Axis - Roller Ball Ways. Y Axis - Double V Ways



G0000638

SGAH600 – Hydraulic X-Axis Feed, Solid-State Relay Y-Axis Feed.  
SGAH800 – Sensor and Solenoid Valve X Axis Feed, Solid State Relay Y Axis Feed

Precision Surface Grinders - Manual Feed						
System Code	Table Size		Table Travel mm		Distance: Spindle to Table	Table Speed
	mm		x	y	mm	
G0000547	450 x 150		450	150	450	manual
Y Axis Wheel Scale mm		Z Axis Wheel Scale mm		Wheel Speed	Motor	
1 rev	1 graduation	1 rev	1 graduation	RPM	kW	V
5	0.02	2	0.01	3500	1.5	380

Precision Surface Grinders - Auto X and Y Feeds							
System Code	Table Size		Table Travel mm		Distance: Spindle to Table	Table Speed	
	mm		x	y	mm		
G0000638	600 x 300		700	340	500	5-25	
Power feed Y axis	Auto Y Axis Feed Increments		Z axis Wheel Scale mm		Wheel Speed	Motor	
	mm		1 rev	1 graduation	Rpm	kW	V
900mm/min	0.1-20 mm		2	0.01	1750	3.8	380
System Code	Table size		Table travel mm		Distance: spindle to table	Table speed	
	mm		x	y	mm		
G0000640	800 x 400		860	450	500	5-25	
Power feed Y axis	Auto Y Axis Feed Increments		Z Axis Wheel Scale mm		Wheel Speed	Motor	
	mm		1 rev	1 graduation	Rpm	kW	V
900mm/min	0.1-20 mm		2	0.01	1750	3.8	380



G0000633

X axis - hydraulic, flat V ways. Y Axis - Solid State Relay, Double V Ways

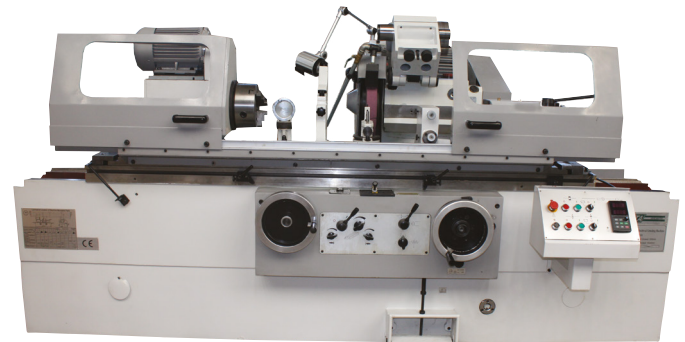

G0000549

Automatic hydraulic feed. Supplied with internal grinding attachments, wheel dresser and balancing arbor  
Model M1432B

Precision Surface Grinders - Auto X and Y Feeds							
System Code	Table Size		Table Travel mm		Distance: Spindle To Table	Table Speed	
	mm		x	y	mm		
G0000633	450 x 200		450	200	450	5-25	
Power Feed X Axis	Auto Y Axis Feed Increments		Z Axis Wheel Scale mm		Wheel Speed	Motor	
	mm		1 rev	1 graduation	Rpm	kW	V
900mm/min	0.1-20 mm		2	0.01	3500	3.8	380

Universal Cylindrical Grinders						
System Code	Distance Between Centres	Centre Height	Workpiece OD	Workpiece ID	Internal Grinding Length	Motor
	mm	mm	Min. mm	Max. mm	mm	kW V
G0000549	1000	180	8-320	30-100	125	1.5 380

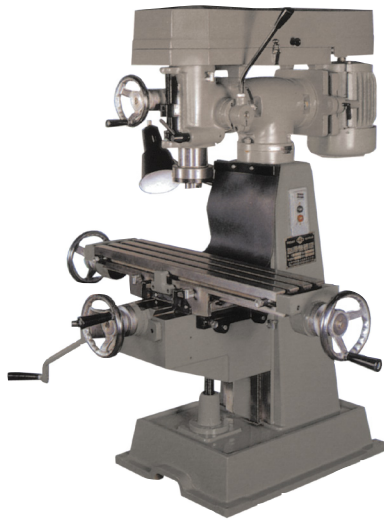

G0004486

Model CES 626

Vertical Milling Machine								
System Code	Spindle Taper	Spindle Travel	Table Size	Table Travel mm		Distance Spindle to Table	Motor	
		mm	mm	x	y		mm	kW
G0004486	R8	80	600 x 152	370	150	6-195	0.75	220

**Optional Extras:** Newall Digital Readout, clamping Kit, Vice, Dividing Head, Angle Plate, Drill and Milling Chuck, Arbors



G0000074

Model UH-1 with Power Feed on Z axis

Universal Milling Machine								
System Code	Spindle Taper H&V	Table Size	Table Travel mm			Motor		
		mm	x	y	z	kW	V	
G0000074	ISO 40	1055 x 240	560	260	260	2.25	380	

**Optional Extras:** Newall Digital Readout, clamping kit, vice, dividing head, angle plate, drill and milling chuck, arbors.



G0000075

Model UH-1

Universal Milling Machine								
System Code	Spindle Taper	Table Size	Table Travel mm			Table Swivel	Motor	
		mm	x	y	z		kW	V
G0000075	ISO 40	1055 x 240	560	260	260	90°	2.25	380

**Optional Extras:** Newall Digital Readout, Clamping Kit, Vice, Dividing Head, Angle Plate, Drill and Milling Chuck, Arbors.

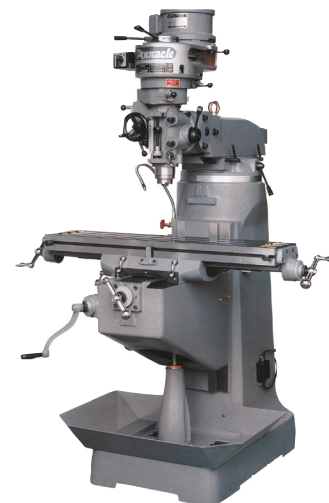

G0000079

Stepped Pulley Head

Meehanite cast iron, hardened and ground slideways. Power feed on the longitudinal axis. Models PK 1 1/2 GRM-KB & PK 1 1/2 GRM-KV

Vertical Turret Milling Machine								
System Code	Spindle Taper	Table Size	Table Travel mm			Spindle Speeds RPM	Motor	
		mm	x	y	z		kW	V
G0000079	R8	1067 x 228	680	305	406	80, 135, 210, 325, 660, 1115, 1750, 2720	1.5	380

**Optional Extras:** Newall Digital Readout, clamping kit, Vice, Dividing Head, Angle Plate, Drill And Milling Chuck, Arbors, Power Feed Attachment for Cross Slide.

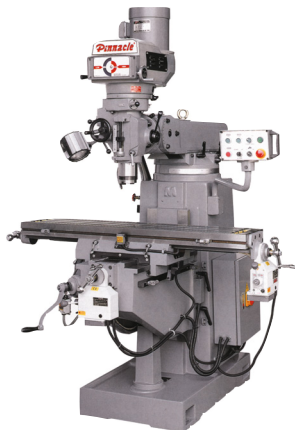

G000077

Meehanite cast iron, hardened and ground slideways. Power feed on the x, y and z axes.  
Model PK-GRSM-V2



Model X715

Variable Speed Vertical Turret Milling Machine									
System Code	Spindle Taper	Table Size		Table Travel mm			Spindle Speeds		Motor
		mm	x	y	z	RPM	kW	V	
G000077	ISO 40	1372 x 254	900	380	380	40-3400	3.75	380	

**Optional Extras:** Newall Digital Readout, Clamping Kit, Vice, Dividing Head, Angle Plate, Drill and Milling Chuck and Arbors.

Bed-Type Universal Swivel Head Milling Machine									
System Code	Spindle Taper	Table Size		Table Travel mm			Spindle Speeds		Motor
		mm	x	y	z	RPM	kW	V	
G000085	ISO 50	2100 X 500	1500	670	670	35-1345	7.5	380	
Max Load On Table		Rapid Feed		Weight					
kg		m/min		kg					
2000		3500		7000					



G000087

Model X6332Z

Vertical Horizontal Milling Machine									
System Code	Spindle Taper	Table Size		Table Travel mm			Spindle Speeds		Motor
		mm	x	y	z	RPM	kW	V	
G000087	ISO 40	1320X320	800 (750)	200	550	90-2000	2.2	380	
Weight									
kg									
2000									



G000084

Model X713

Bed-Type Vari Speed Turret Head Milling Machine									
System Code	Spindle Taper	Table Size		Table Travel mm			Spindle Speeds		Motor
		mm	x	y	z	RPM	kW	V	
G000084	ISO 40	1525X320	1050	470	650	70-3620	3	380	
Weight									
kg									
2300									

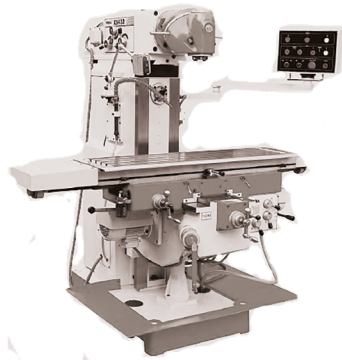

G000088

Model X6432

**Horizontal & Vertical Universal Milling/Drilling Milling Machine**

System Code	Spindle Taper	Table Size mm	Table Travel mm			Spindle Speeds RPM	Motor	
			x	y	z		kW	V
G000088	ISO 40	1320 X 320	1000	300	660	45-1660V 40-1300H	3	380
<b>Weight</b>								
kg								
2100								

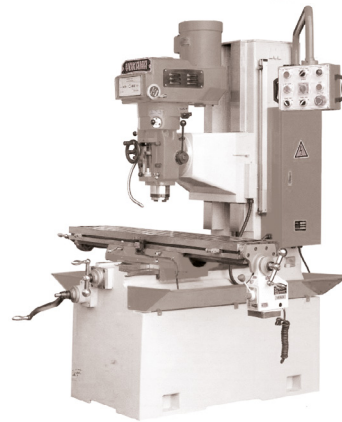

G000076

Robust solid cast bed. Power Feed on the X, Y And Z Axes. Hardened and Ground Slideways and Table. Model YS5BVS

**Variable Speed Bed Type Milling Machine**

System Code	Spindle Taper	Table Size mm	Table Travel mm			Spindle Speeds RPM	Motor	
			x	y	z		kW	V
G000076	ISO 40	250x1370	1000	500	700	70-4200	4	380

**Optional Extras:** Newall Digital Readout, Clamping Kit, Vice, Dividing Head, Angle Plate, Drill Chuck, Er Collet Chuck and Arbors.

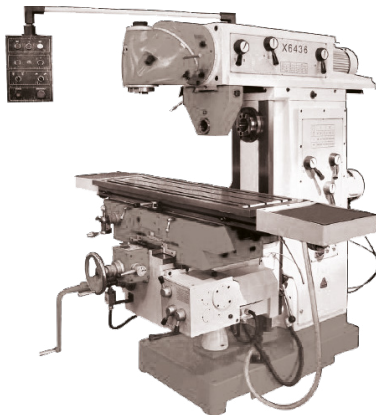

G000088

Model X6436

**Knee Type Universal Horizontal & Vertical Swivel Head Milling Machine**

System Code	Spindle Taper	Table Size mm	Table Travel mm			Spindle speeds RPM	Motor	
			x	y	z		kW	V
G000088	ISO 50	1600 X 360	1300	300	400	58-1800	4	380
<b>Weight</b>								
kg								
2480								

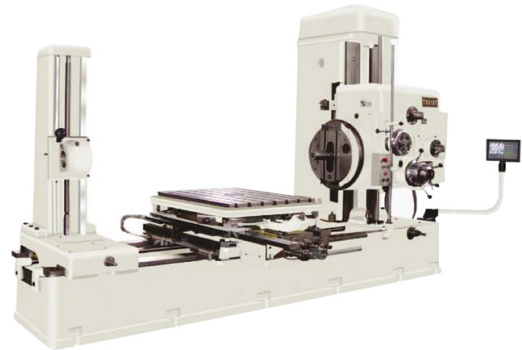

G000690

Model TP (X) 6111B

**Horizontal Milling & Boring Machine**

System Code	Spindle Taper	Table Size mm	Table Travel mm		Spindle Speeds RPM	Table Load kg
			x	z		
G000690	MT	1100x960	960	1000	8-1000	2500
<b>Facing Head Speed</b>		<b>Rapid Feed m/min</b>	<b>Vertical Travel Head Stock</b>		<b>Spindle Travel</b>	<b>Weight kg</b>
RPM			mm			
4-200		2500	900		600	13000





SHD

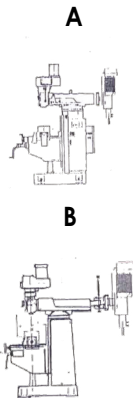

Model TS-125

Slotting Head Attachment Type Flange A & B				
System Code	Flange	Motor kw	Stroke mm	Stroke per Min.
SHD	A	7	125	30,47,69,98,140
System Code	Flange	Motor kw	Stroke mm	Stroke per Min .
G0009394	B	7	125	35,54,79,112,160

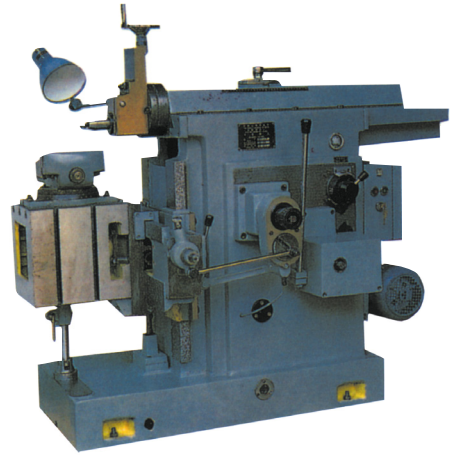

G0000120

Model MB6050B

Shaping Machine							
System Code	Table Size	Table Travel mm		Max Cutting Length mm	Ram Speed Strokes RPM	Motor	
		x	y			kw	V
G0000120	500X380	500	300	500	15-188	3	380



G0004457

Slotting Machine								
System Code	Table Travel mm			Ram Strokes	Ram Strokes / Min RPM	Index Ratio	Motor	
	Ø mm	x	y				kw	V
G0004457	400	300	260	200	26, 43, 74, 100	1:80	1.5	380



MBL1000Ax360/220

Bedways Hardened and Ground. Taper Roller Bearings on Main Spindle.

Geared Head Bench Lathes						
System Code	Model	Distance Between Centres mm	Swing Over Bed	Chuck Ø Mm		
				3 Jaw	4 Jaw	
MBL1000Ax360/220	C0636B	1000	360	160	200	
MBL1000Ax360/380	GHB1340B	1000	360	160	200	
Spindle		Motor				
		kW		V		
38		1.1		220		
38		1.5		380		

**Supplied with Standard Equipment:** Stand, Lathe Chucks, Dead Centres, Steadies, Change Gears and Coolant System.

**Optional Extra:** Digital Readout System, Quick Change Toolposts and Revolving Centres

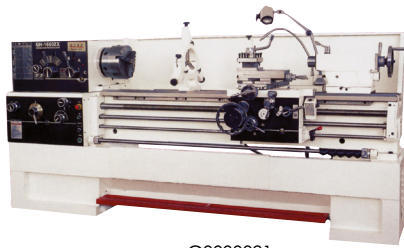

G0000021

Bedways Hardened and Ground. Head Stock Gears Hardened and Ground. Taper Roller Bearings on Main Spindle.



G0000051

Bedways hardened and ground. Head stock gears hardened and ground. Taper roller bearings on main spindle. CY Series

Geared Head Lathes					
System Code	Model	Distance Between Centres	Swing Over Bed	Chuck Ø mm	
		mm		3 Jaw	4 Jaw
				mm	
G0000021	GH1440K	1000	360	160	200
G0000019	GH1640ZX	1000	400	200	250
G0000023	GH1660ZX	1500	400	200	250
L1550A/380	GH1660ZX	1500	410	250	315
G0000030	GHK1880ZX	460	250	315	315
Spindle	Motor				
	kW	V			
38	5.5	380			
52	5.5	380			
52	5.5	380			
80	5.5	380			
80	5.5	380			

Geared Head Lathes					
System Code	Model	Distance Between Centres	Swing Over Bed	Chuck Ø mm	
		mm		3 Jaw	4 Jaw
				mm	
G0000051	CY-L1640G	1000	410	200	250
G0000054	CY-L1660G	1500	410	200	250
Spindle	Motor				
	kW	V			
52	5.5	380			
52	5.5	380			



G0000027

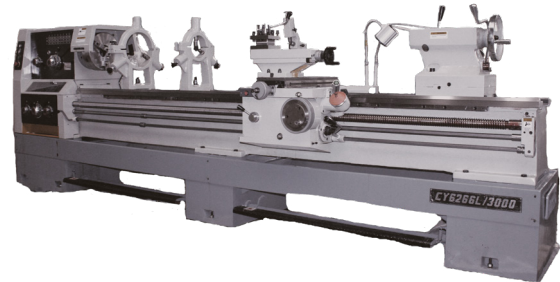

G0000056

Geared Head Lathes					
System Code	Model	Distance Between Centres	Swing Over Bed	Chuck Ø mm	
		mm		3 jaw	4 jaw
				mm	
G0000027	C6250A	1500	500	250	315
G0000031	C6250A	2000	500	250	315
G0000033	C6266C	2000	660	325	400
G0000039	C6266C	3000	660	325	400
Spindle	Motor				
	kW	V			
80	5.5	380			
80	5.5	380			
104	7.5	380			
104	7.5	380			

Geared Head Lathes					
System Code	Model	Distance Between Centres	Swing Over Bed	Chuck Ø mm	
		mm		3 Jaw	4 Jaw
				mm	
G0000056	CY-6250B	1500	500	250	82
G0000031	CY-6250B	2000	500	250	82
G0000033	CY-PML6266L	2000	660	320	104
G0000039	CY-PML6266L	3000z	660	320	104
Spindle	Motor				
	kW	V			
82	7.5	380			
82	7.5	380			
104	11	380			
104	11	380			

**Supplied with Standard Equipment:** lathe Chucks, Dead Centres, Steadies and Change Gears, Coolant System.

**Optional Extra:** Digital Readout System, Quick Change Toolposts, and Revolving Centres

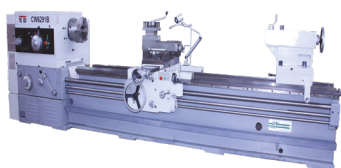

G0000044

**Supplied with Standard Equipment:** lathe chucks, dead centres, steadies and change gears, coolant system.

**Optional Extra:** Digital Readout System, quick change toolposts, revolving centres

Heavy-Duty					
System Code	Model	Distance Between Centres	Swing Over Bed	Chuck Ø mm	
		mm		3 Jaw	4 Jaw
				mm	
G0000044	CW6291B	3000	910	325	500
G0000045	CW6291B	4000	910	325	500
Spindle	Motor				
	kW	V			
104	11	380			
104	11	380			



CNCL360X750

GSK Controller , 4 Position Electric Turret,



CNCLFCL-140

Fanuc Controller, 10 Position Turret, Chip Conveyor, Hydraulic Quill, 52 mm Bar Capacity

CNC Flat Bed Lathe						
System Code	Max Turning Length	Swing Over Bed	Swing Over Crosslide	Chuck Size	Spindle Bore	Spindle Motor
						kW
CNCL360X750	550 1350	360 500	220 290	250 250	50 80	3.7
CNCL-510NX1500						11
CNCL-510NX2000	1800	500	290	250	80	11

**Optional Extras:** Fanuc Control, Hydraulic Chuck, Hydraulic Tailstock , 6 Position Toolpost.

FCL-140 Slant Bed Lathe						
System Code	Max Turning Length	Swing Over Bed	Swing Over Covers	Chuck Size	Spindle Bore	Spindle Motor
						kW
CNCLF-CL-140	290	470	140	150	52	11

**Optional Extras:** Syntec Control, Parts Catcher, Tool Setting Probe and Bar Feeder. Gang Type Tooling.



CNCFCL-120

Fanuc Controller, 8 Position Turret, Chip Conveyor



CNCLFCL-200HT

Fanuc Controller, 10 Position Turret, Chip Conveyor, Hydraulic Quill, Bar Feeder Interface.

FCL-120 Slant Bed Lathe						
System Code	Max Turning Length	Swing Over Bed	Swing Over Covers	Chuck Size	Spindle Bore	Spindle Motor
						kW
CNCF-CL-120	160	400	235	150	45	5.5

**Optional Extras :** Syntec controller, bar feeder, Gang type tooling

FCL-200HT Slant Bed Lathe						
System Code	Max Turning Length	Swing Over Bed	Swing Over Covers	Chuck Size	Spindle Bore	Spindle Motor
						kW
CNCLF-CL-200HT	479	470	318	200	65	15

**Optional Extras :** Syntec controller, Bar feeder, tool setting probes, parts catcher



CNCLFCL-300P

Fanuc Controller, 10 position Turret, Chip Conveyor, Hydraulic Quill and Bar Feed Interface.

FCL-300P Slant Bed Lathe						
System Code	Max Turning Length	Swing Over Bed	Swing Over Covers	Chuck Size	Spindle Bore	Spindle Motor kW
CNCLFCL-300P	700	600	338	250	77	18.5

**Optional Extras:** Bar Feeder, Tool Setting Probes, Parts Catcher and Programmable Tailstock



CNCFBL-360

Fanuc Controller, 10 position turret, Chip Conveyor, Hydraulic Quill and Bar Feed Interface.

FBL-360L Slant Bed Lathe						
System Code	Max Turning Length	Swing Over Bed	Swing Over Covers	Chuck Size	Spindle Bore	Spindle Motor kW
CNCFBL-360	762	770	550	300	91	22/26
CNCFBL-360L	2026	770	550	300	91	22/26

**Optional Extras:** Bar Feeder, Tool Setting Probes, Parts Catcher and Programmable Tailstock



CNCLFBL-300

Fanuc Controller, 10 position turret, chip conveyor, hydraulic quill and bar feed interface

FBL-300 Slant Bed Lathe						
System Code	Max Turning Length	Swing Over Bed	Swing Over Covers	Chuck Size	Spindle Bore	Spindle Motor kW
CNCLFBL-300	594	654	417	250	77	15/18.5
CNCLFBL-300L	1554	654	417	250	77	15/18.5

**Optional Extras:** Bar Feeder, Tool Setting Probes and Parts Catcher



G0006984

GSK Control, ISO40 spindle

CNC Bed Type Turret Mill				
System Code	Table Size	Travel x y z	Spindle Speed RPM	Spindle Motor kW
G0006984	1325 X 320	1050 X 420 X 300	3600	3.7

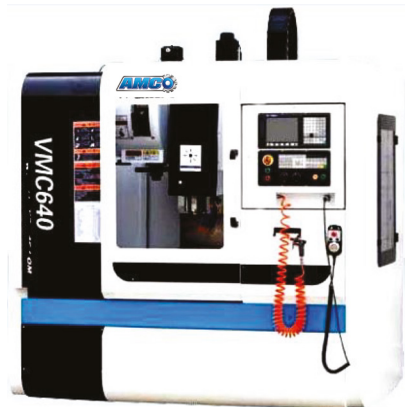

CNCMVMC640/380

GSK Control, 16 position umbrella tool change, BT40 spindle



CNCLV85

Fanuc Oi control 20 Umbrella Type Toolchanger, BT40/50 Spindle

CNC Vertical Machining Centre				
System Code	Table Size	Travel x y z	Spindle Speed RPM	Spindle Motor
				kW
CNCM-VMC640/380	920 x 400	650 x 400 x 500	6000	5.5

**Optional Extras:** Fanuc Control and Arm Type Tool Changer

CNC Machining Centres				
System Code	Table Size	Travel x y z	Spindle Speed RPM	Spindle Motor
				kW
CNCLV85	1000 x 510	850 x 560 x 560	8000	7.5
CNCLV105	1200 x 510	1020 x 560 x 560	8000	11
CNCLV116	1300 x 610	1140 x 610 x 610	8000	11
CNCLV117	1300 x 700	1140 x 710 x 610	8000	11
CNCLV126	1400 x 610	1300 x 610 x 610	8000	15
CNCLV137	1500 x 700	1300 x 710 x 610	8000	11
CNCLV147	1600 x 700	1400 x 710 x 610	8000	15
CNCLV159	1700 x 850	1500 x 900 x 850	8000	15
CNCLV179	2000 x 850	1700 x 900 x 850	8000	18.5
CNCLV209	2200 x 850	2000 x 900 x 850	8000	18.5

**Optional Extras:** Arm type tool change, fourth + fifth axis, through spindle coolant, chip conveyor



KM80ATC16

Syntec Control, 16 Position Tool Change, BT40 Spindle



CNCBX500

Fanuc Oi control 20 Umbrella Type Toolchanger, BT40/50 Spindle

CNC Milling Machines KM100 & KM150				
System Code	Table Size	Travel x y z	Spindle Speed RPM	Spindle motor
				kW
KM80ATC16	355 x 1270	800 x 400 x 450	8000	7.5
G0006976	406 x 1370	1000 x 500 x 530	8000	10
G0006978	450 x 1800	1500 x 650 x 620	8000	15
G0006979	810 x 2180	2000 x 850 x 710	8000	20

CNC Machining Centres				
System Code	Table Size	Travel X Y Z	Spindle Speed RPM	Spindle Motor
				kW
CNCBX500	1450 x 610	1300 x 610 x 810	15000	18
CNCBX700	1600 x 700	1400 x 710 x 810	15000	19.4
CNCBX900	1700 x 850	1500 x 900 x 1100	15000	19.4



### CNC Training Machines - Turning

Our innovative CNC training machine. The 3D animation software simulates the operation and setting of tools and workpieces. Safe and easy operation. No machine collisions, accidents and maintenance. Turning simulator is based on the Fanuc 0iT controller

**System Code : CNCLATHESIM**



### CNC Vertical Machining Centre Designed for Educational and Training Installations

PC controlled Boxford 300VMCi. The inclusive user-friendly software has routines for Computer Aided Design (CAD) at both simple and sophisticated levels and will process both 2D and 3D designs through to a full machining routine.

**System Code : CNCM300VC/220**



X Axis Travel (longitudal): 304mm  
Y Axis Travel (cross): 157mm  
Z Axis Travel (vertical): 213mm  
Table Area: 505 x 135mm

Spindle Motor: 1.2Kw  
Spindle Speed: 200-4000 rpm  
Electrics: 110/220/240 V 1 PHASE

### CNC Training Machines - Milling

Our innovative CNC training machine. The 3D animation software simulates the operation and setting of tools and workpiece. Safe and easy operation. No machine collisions, accidents and maintenance. Milling simulator is based on the Fanuc 0iM controller

**System code : CNCMILLSIM**



### CNC Lathe Designed For Educational And Training Installations

PC controlled Boxford 250PCi. The rigid construction allows steel to be cut to close tolerances. Operating on IBM/100% compatible computers, the inclusive user-friendly software has routines for Computer Aided Design (CAD) at both simple and sophisticated levels and will process the drawing through to a full machining routine.

**System Code : CNCLTCL250/220**



Swing Over bed: 250mm  
X Axis Travel (cross): 200mm  
Z Axis Travel (longitudinal): 265mm

Spindle Drive Motor: 2.2Kw  
Infinitely Variable Spindle Speeds: 200-3200 rpm  
Electrics: 110/220/240v 1 PHASE

CNC Training Machine;

- 1) CNC cutter simulation on a large sized LCD TV screen.
- 2) LCD touch panel to simulate the CNC controller function panel.
- 3) A real user interface operation panel

No Tooling or Material Costs.

\* PC Based Virtual Training Software are also available.



G0009585

Broken Tap Remover	
System Code	Electrode Holder mm
G0009585	1.5-6.0

### Eliminate Oil Mist, Oil Smoke, Welding Fume & Dust

Filtermist provides a comprehensive range of collectors, filters and extraction systems for the reliable removal of oil mist, smoke, fume and dust from the workplace.



System Code	Airflow m3/hr	Motor kw	Noise DBA	Weight kg
FX4002	1250 @ 50Hz 1500 @ 60Hz	1.1	70	24
FX5002	1675 @ 50Hz 2000 @ 60Hz	1.5	71	29
FX6002	2000 @ 50Hz 2400 @ 60Hz	2.2	73	34
FX7002	2750 @ 50Hz	2.2	73	34



G0000553

#### How it works:

1. Oil mist is removed at the source.
2. Oil mist is removed from the air by centrifugal impaction.
3. Clean oil is returned to the machine.
4. Clean air is returned to the workplace.
5. Smoke and fume can be removed and efficiency increased with the addition of a clip-on afterfilter.



A perforated drum with specially designed vains rotates at high speed. Oil mist is drawn into the unit and impacts on its vains at high velocity. Special drum pads assist the coalescing process and filter out stray solid particles. Centrifugal force pushes oil to the unit's outer case where it drains back to the machine for re-use or collection and clean air is returned to the workshop through the top of the unit

#### Application Examples :



Electrical Discharge Machine				
System Code	Table Size	Travel	Max. Work Piece Weight	Work Tank
		X x Y x Z		W x D x M
G0000553	600 X 300	300 X 200 X200	550	830 X 500 X 300
G0000554	600 X 400	400 x 300 x 200	900	1060 x 600 x 340

ZNC or CNC Options.

ADMINISTRATIVE / LIGHT-DUTY



- SINGLE-ACTING, SPRING RETURN**
- Lightweight, easy to carry and position
  - Handles standard on all models.



- WITH LOCK NUT, SPRING RETURN**
- With lock nut to secure loads mechanically
  - Lightweight, easy to carry and position
  - Handles standard on all models.

HEAVY-DUTY / LONG-STROKE



- HEAVY-DUTY, LONG-STROKE**
- Plunger and collar threads, base mounting holes
  - Solid plunger design; built-in safety valve
  - For industrial, construction and high-cycling production applications.

Model Number*	Cylinder Capacity (kN)	Stroke (mm)	Collapsed Height (mm)
RAC-202	218	50	174
RAC-204	218	100	224
RAC-206	218	150	274
RAC-302	309	50	181
RAC-304	309	100	231
RAC-306	309	150	281
RAC-502	496	50	186
RAC-504	496	100	236
RAC-506	496	150	286
RAC-1004	1002	100	271
RAC-1006	1002	150	321
RAC-1008	1002	200	371
RAC-1506	1589	150	343

Model Number*	Cylinder Capacity (kN)	Stroke (mm)	Collapsed Height (mm)
RACL-302	309	50	231
RACL-304	309	100	281
RACL-306	309	150	331
RACL-502	496	50	236
RACL-504	496	100	286
RACL-506	496	150	336
RACL-1002	1002	50	296
RACL-1004	1002	100	346
RACL-1006	1006	150	396
RACL-1502	1589	50	323
RACL-1504	1589	100	373
RACL-1506	1589	150	423

\* Custom strokes available.

Model Number	Cylinder Capacity (kN)		Stroke (mm)	Collapsed Height (mm)
	Push	Pull		
RR-1010	101	33	254	409
RR-1012	101	33	305	457
RR-308	295	53	209	395
RR-3014	295	53	368	549
RR-506	498	103	156	331
RR-5013	498	103	334	509
RR-1006	933	435	168	357
RR-10013	933	435	333	524
RR-1506	1386	668	156	385
RR-15013	1386	668	333	582
RR-2006	1995	1017	152	430
RR-20013	1995	1017	330	608



- HOLLOW PLUNGER, SINGLE-ACTING**
- Hollow plunger design allows for both pull and push forces
  - Lightweight, easy to carry and position
  - Handles standard on all models.



- SOLID PLUNGER, DOUBLE-ACTING**
- Double-acting for rapid plunger retraction
  - Safety valve prevents overpressurization
  - Lightweight, easy to carry and position
  - Handles standard on all models.



- PRECISION PRODUCTION, DOUBLE-ACTING**
- Unique mounting configurations simplify fixturing
  - Designed for long life; the best choice for production applications.

Model Number*	Cylinder Capacity (kN)	Stroke (mm)	Collapsed Height (mm)
RACH-202	229	50	188
RACH-206	229	150	315
RACH-302	358	50	208
RACH-306	358	150	333
RACH-604	596	100	315
RACH-606	596	150	380
RACH-1002	1157	50	258
RACH-1006	1157	150	391
RACH-1502	1588	50	280
RACH-1506	1588	150	430

\* Custom strokes available.

Model Number*	Cylinder Capacity (kN)		Stroke (mm)	Collapsed Height (mm)
	Push	Pull		
RAR-202	218	130	50	189
RAR-206	218	130	150	289
RAR-302	309	179	50	201
RAR-306	309	179	150	301
RAR-502	496	187	50	201
RAR-504	496	187	100	251
RAR-506	496	187	150	301
RAR-1004	1002	557	100	301
RAR-1006	1002	557	150	351
RAR-1008	1002	557	200	401
RAR-1506	1589	924	150	348

\* Custom strokes available.

Model Number	Cylinder Capacity (kN)		Stroke (mm)	Collapsed Height (mm)
	Push	Pull		
BRD-41	35	16	28	186
BRD-43	35	16	79	237
BRD-46	35	16	155	313
BRD-91	80	44	28	223
BRD-93	80	44	79	274
BRD-96	80	44	155	350
BRD-910	80	44	257	452
BRD-166	142	77	159	389
BRD-1610	142	77	260	491
BRD-256	222	98	159	424
BRD-2510	222	98	260	526



SINGLE-ACTING HIGH-TONNAGE



SINGLE-ACTING, LOAD RETURN

- Integral stop ring provides piston blow-out protection
- Plunger wiper reduces contamination ingress, extending cylinder life.

Model Number*	Cylinder Capacity (kN)	Stroke (mm)	Collapsed Height (mm)
CLSG-506	539	150	262
CLSG-5010	539	250	362
CLSG-1002	929	50	182
CLSG-1006	929	150	282
CLSG-10010	929	250	382
CLSG-1502	1390	50	196
CLSG-1506	1390	150	296
CLSG-15010	1390	250	396
CLSG-2002	1861	50	216
CLSG-2006	1861	150	316
CLSG-20012	1861	300	466
CLSG-25012	2565	300	485
CLSG-30012	3193	300	562
CLSG-40012	3919	300	625
CLSG-50012	5114	300	669
CLSG-60012	5987	300	679
CLSG-80012	8234	300	724
CLSG-100012	10260	300	814

\* All models are available in 50 mm stroke increments from 50 to 300 mm. NOTE: All cylinders meet ASME B30.1 and ISO 10100 standards.

DOUBLE-ACTING HIGH-TONNAGE



DOUBLE-ACTING, HYDRAULIC RETURN

- Safety valve in retract side of cylinder helps to prevent damage in case of over-pressurization
- Plunger wiper reduces contamination ingress, extending cylinder life.

Model Number*	Cylinder Capacity (kN)		Stroke (mm)	Collapsed Height (mm)
	Push	Pull		
CLRG-502	539	269	50	162
CLRG-506	539	269	150	262
CLRG-5010	539	269	250	362
CLRG-1002	929	433	50	179
CLRG-1006	929	433	150	279
CLRG-10010	929	433	250	379
CLRG-1502	1390	675	50	196
CLRG-1506	1390	675	150	296
CLRG-15010	1390	675	250	396
CLRG-2002	1861	889	50	212
CLRG-2006	1861	889	150	312
CLRG-20012	1861	889	300	462
CLRG-2502	2565	1068	50	235
CLRG-2506	2565	1068	150	335
CLRG-25012	2565	1068	300	485
CLRG-30012	3193	1060	300	572
CLRG-40012	3919	1354	300	624
CLRG-50012	5114	1733	300	669
CLRG-60012	5987	2068	300	679
CLRG-80012	8234	2709	300	734
CLRG-100012	10260	3792	300	814

\* All models are available in 50 mm stroke increments from 50 to 300 mm. NOTE: All cylinders meet ASME B30.1 and ISO 10100 standards.

LOW PROFILE HIGH-TONNAGE



SINGLE-ACTING, LOAD RETURN

- Safety Lock Nut for mechanical load holding
- Synthetic coating for improved corrosion resistance and lower friction
- Interchangeable, hardened grooved saddles.

Model Number*	Cylinder Capacity (kN)	Stroke (mm)	Collapsed Height (mm)
CLL-506	496	150	264
CLL-5010	496	250	364
CLL-1002	929	50	187
CLL-1006	929	150	287
CLL-10010	929	250	387
CLL-1502	1390	50	209
CLL-1506	1390	150	309
CLL-15010	1390	250	409
CLL-2002	1859	50	243
CLL-2006	1859	150	343
CLL-20012	1859	300	493
CLL-2502	2562	50	249
CLL-25012	2562	300	499
CLL-3002	3193	50	295
CLL-30012	3193	300	545
CLL-40012	3919	300	585
CLL-50012	5118	300	625
CLL-60012	5983	300	645
CLL-80012	8238	300	705
CLL-100012	10260	300	745

\* All models are available in 50 mm stroke increments from 50 to 300 mm.

LOW PROFILE LOCK-NUT



SINGLE-ACTING, LOAD RETURN

- Extremely low profile for use in confined areas
- Lock nut for mechanical load holding safety
- Optional special synthetic coating for improved corrosion resistance and lower friction for smoother operation
- Includes integral swivel saddle.

Model Number	Cylinder Capacity (kN)	Stroke (mm)	Collapsed Height (mm)
CLP-1002	1027	50	137
CLP-1602	1619	45	148
CLP-2002	1999	45	155
CLP-2502	2567	45	159
CLP-4002	3916	45	178
CLP-5002	5114	45	192

SPREADERS

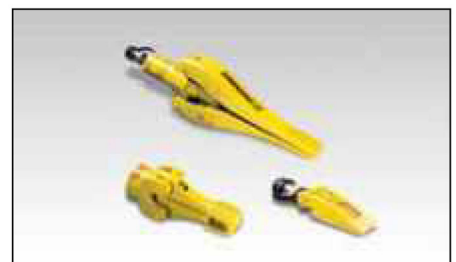

SINGLE-ACTING, SPRING RETURN

- WR-5: for use in very confined areas
- WR-15: for long stroke spreading
- A-92: spreader attachment.

Model Number	Capacity (kN)	Tip Clearance (mm)	Maximum Spread (mm)	Oil Capacity (cm <sup>3</sup> )
WR-5	8,9	12,8	94	10
WR-15	6,0	32,0	292	64
A-92*	8,9	35,0	158	-

\* Threads onto RC-Series 10 ton cylinders (except RC-101).

JACKS



JHA-SERIES SAF-T-LITE<sup>®</sup> ALUMINIUM JACKS

- All-directional operation on 62, 133 and 311 kN
- Vertical and horizontal operation other models

JH-SERIES PREMIUM STEEL JACKS

- Chrome plated plungers
- Machined flat front and bottom surfaces permit flush alignment in tight corners.

Model Number	Capacity (kN)	Stroke (mm)	Collapsed Height (mm)
JHA-73	62	76	133
JHA-156	133	153	247
JHA-356	311	155	257
JHA-756	667	153	285
JHA-1506	1335	155	327
JH-306	267	155	254
JH-506	445	154	260
JH-1006	890	153	287

POWER RISE LIFTING JACKS



DOUBLE-ACTING, HYDRAULIC RETURN

- 54, 90, 136, 181 ton capacities with pneumatic or electric pumps for the toughest jobs
- 3-pos. handle provides easy tilt and transport
- Complies with ASME B30.1 specifications.

Model Number*	Capacity (kN)	Stroke (mm)	Collapsed Height (mm)
PRAMA06014L	533	356	610
PREME06014L	533	356	610
PRAMA06027L	533	686	940
PREME06027L	533	686	940
PRAMA10016L	889	406	660
PREME10016L	889	406	660
PRAMA10027L	889	686	940
PREME10027L	889	686	940
PRASA15016L	1333	394	660
PRASA15027L	1333	673	940
PREME15016L	1333	394	660
PREME15027L	1333	673	940
PRASA20016L	1778	394	660
PRASA20027L	1778	673	940

\* PRA with air pump; PRE with electric pump.

POWER LOCK<sup>®</sup> PORTABLE LIFT SYSTEM



DOUBLE-ACTING, HYDRAULIC RETURN

- Provides continuous locking protection during lift, lower and hold functions
- Simple 2-button pendant allows operation of raise and lower functions from up to 6 m away
- Meets ANSI B30.1-2009, AS/NZS-2538, AS/NZS-2693 certification criteria.

Model Number*	Capacity (kN)	Stroke (mm)	Collapsed Height (mm)
PL20014-ASA	1779	356	864
PL20025-ASA	1779	622	1156

\* With air pump.

SPECIALTY LIFTING TOOLS



HYDRAULIC MACHINE LIFTS

- For lifting heavy equipment with minimal access
- Separate hydraulic pump enhances safety
- Adjustable toe starting height
- Extendible support feet provide extra stability
- Includes RC-DUO Series single-acting, spring return cylinder with CR-400 coupler.

Model Number	Capacity (kN)	Stroke (mm)	Toe Position (mm)			Oil Cap. (cm <sup>3</sup> )
			min.	central	max.	
SOH-10-6	75	136	20	95	169	224
SOH-23-6	178	157	30	110	190	525



VERTICAL LIFTING WEDGE

- Requires 10 mm access gap
- 21 mm of vertical lift from each step (max. lift to 69 mm with optional LWB-1 stepped block)
- Each step can spread under full load
- Automatic mechanical retraction (single-acting).

Model Number	Capacity (kN)	Lifting Stroke (mm)	Tip Clearance (mm)	Oil Capacity (cm <sup>3</sup> )
LW-16	157	21	10	78

CYLINDER PUMP SETS



SINGLE-ACTING CYLINDER PUMP SETS

- Optimum component match
- 1.8 m safety hose, with gauge and adaptor
- 2-speed lightweight hand pump P-392.

Model Number	Cylinder Capacity (kN)	Cylinder Model Nr.	Cylinder Stroke (mm)
SCR-106H	101	RC-106	156
SCR-252H	232	RC-252	50
SCL-101H	101	RCS-101	38
SCL-302H	295	RCS-302	62
SCH-202H	215	RCH-202	49

## World Class Pumps

When it comes to increasing productivity, labor efficiency and speed of operations, Enerpac high-pressure tools and components provide a significant hydraulic advantage. With a 100-year history of quality and innovation and the broadest line of hydraulic tools and components in the business, Enerpac leads the industry by setting new standards in design, strength and durability. Strict quality programs, zero tolerance for defects, and ISO-9001 certification are your assurance of safe, trouble-free operation.

## HYDRAULIC HAND PUMPS



### COMPOSITE HYDRAULIC HAND PUMPS

- Lightweight design; impact and corrosion resistant
- Two-speed operation for fast and easy operation (except P-141, P-391)
- Handle lock for easy carrying.



### STEEL HYDRAULIC HAND PUMPS

- Reduced handle effort and ergonomic grip for less operator fatigue
- Two-speed operation for fast and easy operation
- Quick grip handle allows for easy transport
- All steel construction, chrome plated plunger and wiper system for durable, long lasting performance.

## CORDLESS PUMPS



- Lightweight design with integrated handle and carrying strap for portability
- Bladder reservoir prevents contamination and allows pump usage in any position
- Powerful 0,37 kW motor and 28 Volt Lithium-Ion battery deliver exceptional speed and run time.

Model Number	Charger Voltage 0/AC	Output Flow Rate (l/min)			Usable Oil Capacity (litres)
		No Load	140 bar	700 bar	
XC-1201MB	115	2,0	0,50	0,25	1,0
XC-1202MB	115	2,0	0,50	0,25	2,0
XC-1201ME	230	2,0	0,50	0,25	1,0
XC-1202ME	230	2,0	0,50	0,25	2,0
XC-1201M*	-	2,0	0,50	0,25	1,0
XC-1202M*	-	2,0	0,50	0,25	2,0

Note: All models for use with single-acting tools and cylinders. \* Batteries and charger not included.



- Bi-directional pumping (P-25 and P-50)
- For single-acting tools and cylinders
- Single-speed operation.

Model Number	Maximum Pressure (bar)	Displacement per stroke (cm <sup>3</sup> )	Usable Oil Capacity (cm <sup>3</sup> )
P-18	200	2,46	360
P-25	175	9,50	3277
P-50	350	4,75	3277
P-51	200	4,10	819



- Two-speed operation for faster fill, reducing cycle times for many testing operations (P-2282)
- 303 stainless steel construction for use with distilled water, diesters, silicones, soluble oils and petroleum (11-100, 11-400).

Model Number	Maximum Pressure (bar)	Displacement per stroke (cm <sup>3</sup> )		Usable Oil Capacity (cm <sup>3</sup> )
		1st	2nd	
P-2282	2800	16,22	0,61	983
11-100	700	-	2,49	737
11-400	2800	-	0,62	737

Z-CLASS ELECTRIC HYDRAULIC PUMPS



ZU4-SERIES ELECTRIC PUMPS

- High-efficiency pump has higher oil flow and bypass pressure, runs cooler and requires 18% less current draw than comparable pumps
- Powerful 1,25 kW universal electric motor provides high power-to-weight ratio and excellent low-voltage operating characteristics.

Model Number*	LCD	For Cyl. **	Valve Type	Usable Oil Capacity (litres)
ZU4108DE	•	S/A	Electric Dump 3/2	8,0
ZU4308ME	-	S/A	Manual 3/3	8,0
ZU4320ME	-	S/A	Manual 3/3	20,0
ZU4208SE	•	S/A	Electric 3/2	8,0
ZU4408SE	•	D/A	Electric 4/3	8,0
ZU4308JE	-	S/A	Manual 3/3	8,0
ZU4408JE	-	D/A	Manual 4/3	8,0

\* 240V-1phase 50/60 Hz. Output oil flow 1,0 l/min at 700 bar.

\* S/A = single-acting; D/A = double-acting.



ZE-SERIES ELECTRIC PUMPS

- High-efficiency pump has higher oil flow and bypass pressure, runs cooler and requires 18% less current draw than comparable pumps
- ZE3: 0,75 kW, 0,55 l/min at 700 bar;  
ZE4: 1,12 kW, 0,82 l/min at 700 bar;  
ZE5: 2,24 kW, 1,64 l/min at 700 bar;  
ZE6: 5,6 kW, 2,73 l/min at 700 bar.

Model Number	LCD	For Cyl.	Valve Type	Usable Oil Capacity (litres)
ZE3108DW	•	S/A	Electric Dump 3/2	8,0
ZE3208MW	-	S/A	Manual 3/2	8,0
ZE4308MW	-	S/A	Manual 3/3	8,0
ZE4420LW	•	D/A	Manual 4/3	20,0
ZE4308SW	•	S/A	Electric 3/3	8,0
ZE5410SW	•	D/A	Electric 4/3	10,0
ZE5420SW	•	D/A	Electric 4/3	20,0
ZE6440SW	•	D/A	Electric 4/3	40,0

\* S/A = single-acting; D/A = double-acting.

Z-CLASS AIR HYDRAULIC PUMPS



ZA4-SERIES AIR HYDRAULIC PUMPS

- High efficiency pump design; higher oil flow and bypass pressure than comparable pumps
- Two speed operation and high by-pass pressure reduces cycle time for improved productivity
- Output flow rate 1,3 l/min at 700 bar
- ATEX rated
- 2840 l/min air consumption.

Model Number	For Cylinder*	Valve Type	Usable Oil Capacity (litres)
ZA4204MX	S/A	Manual 3/2	4,0
ZA4308MX	S/A	Manual 3/3	8,0
ZA4220MX	S/A	Manual 3/2	20,0
ZA4404MX	D/A	Manual 4/3	4,0
ZA4408MX	D/A	Manual 4/3	8,0
ZA4410MX	D/A	Manual 4/3	10,0
ZA4420MX	D/A	Manual 4/3	20,0
ZA4440MX	D/A	Manual 4/3	40,0

\* S/A = single-acting; D/A = double-acting.



PU-SERIES ECONOMY PUMPS

- Lightweight and compact
- Highest oil-flow-to-weight ratio:  
3,31 l/min at 13 bar; 0,32 l/min at 700 bar
- Single-phase 50/60-cycle universal 0,37 kW motor.

Model Number	For Cylinder*	Valve Type	Usable Oil Capacity (litres)
PUD-1100E	S/A	Dump valve 3/2 *	1,9
PUJ-1200E	S/A	Manual 3/2	1,9
PUJ-1201E	S/A	Manual 3/2	3,8
PUJ-1400E	D/A	Manual 4/3	1,9

\* S/A = single-acting; D/A = double-acting.

\*\* Electric dump valve for auto-retract.



PA-SERIES TURBO II AIR PUMPS

- Operating air pressure: 2,8 - 8,8 bar
- Quiet 76 dBA, low air consumption 340 l/min

XA-SERIES FOOT PUMPS

- Ergonomic design for less operator fatigue
- Variable oil flow and fine metering for precise control.

Model Number	For Cyl.	Oil Flow (l/min)		Valve Type	Usable Oil Capacity (litres)
		No Load	700 bar		
PATG-1102N	S/A	1,0	0,16	3/3	2,0
PAMG-1402N	D/A	1,0	0,16	4/3	2,0
PARG-1102N	S/A	0,76	0,10	3/3	2,0
XA11	S/A	2,0	0,25	3/3	1,0
XA11G**	S/A	2,0	0,25	3/3	1,0

• Remotependant controlled.

\*\*With integrated pressure gauge.

\*\*\* S/A = single-acting; D/A = double-acting.



ZG-SERIES Z-CLASS PUMPS

- Features high efficiency pump design; higher oil flow and bypass pressure than comparable pumps

PGM-SERIES ATLAS PUMPS

- 4-cycle 2,2 kW Honda motor.

Model Number	For Cyl.	Engine (kW)	Oil Flow (l/min)	Valve Type	Usable Oil Capacity (litres)
PGM-2304R	S/A	2,2	0,66	3/3	3,8
PGM-2404R	D/A	2,2	0,66	4/3	3,8
ZG5410MX-R	D/A	4,1	1,60	4/3	10,0
ZG5410MX-BR	D/A	4,8	1,60	4/3	10,0
ZG6440MX-BCFH	D/A	9,7	3,30	4/3	40,0

\* S/A = single-acting; D/A = double-acting.

\* Oil flow at 700 bar.

PIPE BENDERS



QUICK, SAFE AND WRINKLE-FREE BENDING

- Set includes pump, cylinder, hose, bender frame and bending shoes
- Pipe range ½ - 4 inch nominal bore size
- With bending angle indicator for accuracy and convenience.

Model Number*	Pipe Range Nominal Bore (inch)	
	one shot	sweep
STB-101E	½-2	-
STB-221H	1-2	2½-4
STB-202E	1¼-4	-

\* E = with electric pump,  
H = with hand pump.

PULLERS



POSI LOCK® PULLERS

- Patented "safety cage" jaw retention system
- Roll-threaded shafts for less effort when applying high torque
- Available in 2- and 3-jaw designs as well as inside and outside pulling configurations
- Also available with a 100 ton hydraulic grip puller.

Model Number (3jaws)	Capacity (kN)	Spread of Jaws (mm)	Operation
EP-106	89	12-178	Manual
EP-110	178	25-381	Manual
EPH-110	142	25-381	Hydraulic •
EPH-113	232	63-457	Hydraulic •

\* Cylinder not included.



MULTI-PURPOSE PULLER SETS

- Set comes with hand pump, hose, cylinder, gauge, adaptor and case
- Also includes: grip puller, cross bearing puller, bearing cup and bearing puller attachments
- Quick set-up for a variety of jobs.

Model Number	Capacity (kN)	Grip Pullers*		Cross Bearing*		Bearing Cup*	
		R	S	R	S	R	S
BHP-1752	71	252	249	462	266	110	110
BHP-2751G	178	300	499	571	351	140	220
BHP-3751G	267	387	800	711	454	145	359
BHP-5751G	445	700	1100	863	570	145	359

\* R = maximum reach in mm,  
\* S = maximum spread in mm.

HYDRAULIC PUNCH



MUCH FASTER THAN DRILLING

- Punches mild steel up to 12,7 mm thickness
- Durable steel case keeps tools and dies together and provides for easy carrying and storage
- Round, oblong and square punches and dies available
- Available as Tool-Pump Sets with hose, gauge, adaptor and pump.

Model Number	Capacity (kN)	Round Punch & Die Sets			
		Included	Hole Size [(mm)(inch)]	Bolt Size	Bolt Size
SP-35S	311	SPD-438	11,1   0,44	M10	¾
		SPD-563	14,3   0,56	-	½
		SPD-688	17,5   0,69	M16	¾
		SPD-813	20,6   0,81	-	¾

MANUFACTURE SETS



THE UNIVERSAL HYDRAULIC TOOL BOX

- Power to push, pull, lift, press, straighten, spread and clamp
- Sets include Enerpac lightweight hand pump, 1,8 m hose, single-acting cylinder(s), gauge and adaptor
- Numerous attachments permit quick configuration of specialized tools.

Model Number	Capacity* (kN)	Number of Attachments	Cylinder(s) Included
MS2-4	22	35	RC-55
MS2-10	50	40	RC-106
MS2-20	116	19	RC-256
MS2-1020	50-116	59	RC-102, 106, 256

\* When cylinders are used with attachments, the maximum system pressure must be limited to half the rated pressure (350 bar).

HYDRAULIC CUTTERS



IDEAL FOR A WIDE RANGE OF MATERIALS

- Spring return for easy operation
- Self-contained (WMC) and pump powered (WHC) models available
- Guillotine action for smooth cutting operation
- Rotating head for operator convenience.

Model Number	Capacity (kN)	Maximum Cutting Capacity (0mm)			
		Bar	Bolt	Wire	Cable
WMC-750	40	17	17	19	17
WMC-1250	195	28	31	31	-
WMC-2000	127	31	22	50	50
WHC-750 •	40	19	19	19	-
WHC-1250 •	195	28	28	31	-
WHC-2000*	127	31	22	50	50

\* Recommended hand pump for WHC-Cutterheads: P-392.

PRESSES



BENCH AND WORKSHOP PRESSES

- Height adjustment of upper or lower bed with winch (XLP 50 and 75 ton)
- Width adjustment allows cylinder to move from side-to-side
- Pump options include XA-Series air-operated foot pump: suitable for delicate pressing jobs from variable oil flow.

Model Number	Capacity (kN)	Pump Type	Cylinder Stroke (mm)	Maximum Daylight H x W (mm)
VLP-106P142	101	Manual	156	430 x 435
XLP-256P392	232	Manual	158	1225 x 510
XLP-256XA11G	232	Air	158	1225 x 510
XLP-506P802	498	Manual	159	993 x 990
XLP-506XA12G	498	Manual	159	993 x 990
XLP-5013ZES*	498	Electric	334	993 x 990
XLP-756XA12G	718	Air	156	989 x 990
VLP-10013ZES*	933	Electric	333	989 x 990
VLP-20013ZES*	1995	Electric	330	1340 x 1220



ROLL-FRAME PRESSES

- Roller head design to allow lateral movement and locking of the cylinder
- Frame rolls easily on four steel roller bearings
- Effortless adjustment of vertical daylight
- With ZE-Series electric pump.

Model Number	Capacity (kN)	Vertical Daylight min. - max. (mm)	Max. Bed Width (mm)	Cylinder Stroke (mm)
BPR-5075	498	152- 942	730	334
BPR-10075	933	159-1048	889	333
BPR-20075	1995	279-1295	1219	330



C-CLAMP PRESSES

- Operational in all positions.

ARBOR PRESSES

- Machined working surfaces for easier fixturing
- Foot mouning holes for horizontal or vertical positioning
- Slotted back simplifies loading and unloading of longer parts.

Model Number	Press Type	Press Capacity (kN)	Maximum Daylight H x W (mm)
A-205	C-Clamp	45	51 x 165
A-210	C-Clamp	101	57 x 228
A-220	C-	178	70 x 305
A-310	Clamp	101	135 x 230
A-330	Arbor	295	178 x 260

PRESSURE GAUGES



GLYCERINE FILLED PRESSURE GAUGES

- Dual scale reading in psi and bar
- All pressure sensing parts sealed and dampened by glycerine for long life
- Includes safety blow-out disk and pressure equalizing membrane
- GA45GC includes gauge, coupler and 45° adaptor.

Model Number	Face 0 (mm)	Connection (NPTF)	Pressure Range (bar)   (psi)
G2531R	63	1/4" Center Rear	0-70   0-1000
G4088L	100	1/4" Lower Mount	D-700   0-10.000
G4039L	100	1/2" Lower Mount	0-700   0-10.000
GA45GC	63	3/8" Lower Mount	D-700   0-10.000



HOSES, COUPLERS AND HYDRAULIC OIL

- Thermoplastic hoses, 2800bar burstpressure
- 700bar high flow coupler, 3/8"-18NPTF, 17l/min maximum oil flow
- Premium hydraulic oil: prevents pump cavitation, additives prevents rust, oxidation and sludge.

Model Number	Description
H-7210	Hose length 3,0m, 3/8" NPTF
H-7220	Hose length 6 m 3/8 NPTF
HC-7206	Hose length 18m, 3/8" includes CH-604
HC-7210	Hose length 3,0m, 3/8" includes CH-604
HC-7220	Hose length 6,1m , 3/8" includes CH-604 3/8" High flow
CR-400	female half high flow coupler
CH-604	3/8" Male half high flow
HF-95X	coupler Premium hydraulic
HF-95Y	Premium hydraulic oil, 5litres
HF-95T	Premium hydraulic oil, 20litres



FLOW CONTROL VALVES

- Rated for 700bar operating pressure
- NPTF porting to insure against leakage at rated pressure
- All valves are painted, coated, or plated for corrosion resistance.

Model Number	Description
V-82	Needle valve
V-182	Needle valve
V-8F	Needle valve
V-91	Snubber valve
V-10	Auto damper valve
V-17	Check valve
V-42	Pilot operated check valve
V-66	Manually operated check valve
V-66F	Manually operated check valve
V-152	Pressure relief valve
V-161	Sequence valve

## World Class Bolting Tools

Enerpac's Bolting Tools caters to the complete bolting work-flow, ensuring joint integrity in a variety of applications throughout industry:

**Joint Assembly:** Enerpac's comprehensive line of joint assembly products range from hydraulic and mechanical alignment tools to PLC-controlled multi-point positioning systems.

**Controlled Tightening:** From mechanical torque multipliers to hydraulically driven square drive wrenches, and from low profile torque wrenches to inter-connectable bolt tensioning tools; Enerpac offers the products you need for accurate and simultaneous tightening of multiple bolts.

**Joint Separation:** Enerpac also provides hydraulic nut splitters and a variety of mechanical and hydraulic spreading tools for joint separation during inspection, maintenance and decommissioning operations.

## FLANGE MAINTENANCE TOOLS



### PARALLEL WEDGE SPREADERS

- Lightweight, portable, easy to use, one person operation
- FSM-8 mechanical version
- FSH-14 hydraulic version also available as set STF-14H including pump, hose and gauge.



### FLANGE ALIGNMENT TOOLS

- Easy to use, one person operation
- Corrects twist and rotational misalignment without additional stress in pipelines
- For most commonly used ANSI, API, BS and DIN flanges.

## HYDRAULIC NUT SPLITTERS

Model Number	Max. Spreading Force (kN)	Tip Clearance (mm)	Max. Spread* (mm)	Oil Capacity (cm <sup>3</sup> )
FSM-8	72	6	80	-
FSH-14	125	6	80	78

\* Using optional stepped block FSB-1.

Model Number	Max. Lifting Force (kN)	Minimum Bolt Size		Flange Wall Thickness	
		(inch)	(mm)	(inch)	(mm)
ATM-2	10	.63	16	.55-3.29	14-82
ATM-4	40	.95	24	1.18-5.23	30-133
ATM-9 *	90	1.24	31.5	3.66 - 9.00	93 - 228

\* At 700 bar max. pressure. ATM-9 includes Enerpac P-142 hand pump and HC-7206C 1,8 m hydraulic hose.

## RETRACTABLE FLANGE SPREADERS



### NC-SERIES NUT CUTTERS

- Compact, ergonomic, lightweight design
- Single-acting, spring return

### NS-SERIES NUT SPLITTERS

- Designed to suit ANSI 816.5/BS1560 flanges
- Interchangeable heads for max nut range flexibility
- Single-acting, spring return.

Model Number	Capacity (kN)	Bolt Range (mm)	Hexagon Nut Sizes (mm)	Oil Capacity (cm <sup>3</sup> )
NC-1319	49	M6- M12	10- 19	15
NC-1924	98	M12- M16	19- 24	20
NC-2432	147	M16- M22	24- 32	60
NC-3241	196	M22- M27	32- 41	80
NC-4150	343	M27- M33	41- 50	155
NC-5060	490	M33- M39	50- 60	240
NC-6075	882	M39- M48	60- 75	492
NS-7080	917	M45- M52	70- 80	377
NS-70105	917	M45- M72	70- 105	377
NS-110115	1711	M76-M80	110-115	819
NS-110130	1711	M76-M90	110-130	819



### PIN TYPE FLANGE SPREADERS

- Lightweight and ergonomic design
- Adjustable jaw widths from 70 to 216 mm for a wide range of applications
- Available as a complete set including tool, pump, hose, coupler, gauge and adaptor:  
STF-56H set with P-392 hand pump;  
STF-109H set with P-392 hand pump;  
STF-109A set with PATG-1102N Turbo Air hydraulic pump.

Model Number	Capacity (kN)	Maximum Flange Thickness (mm)	Stud Size (mm)	Stroke (mm)
FS-56	45	2 x57	19 - 28	38
FS-109	101	2 X 92	31 - 41	54

## MANUFACTURE TORQUE MULTIPLIERS



### ACCURATE TORQUE MULTIPLICATION

- Reversible, tighten or loosen nuts and bolts
- Provides high output torque for accurate make-up or break-out of fasteners
- 1/2 inch female input square drive.

Model	Output Torque	Number Capacity (Nm)	Input Torque (Nm)	Torque Ratio	Output Male Square Drive (inch)
E391	1625	271	6: 1	¾	
E392	2980	219	13,6: 1	1	
E393	4340	234	18,5: 1	1	
E492	2980	219	13,6: 1	1	
E493	4340	234	18,5: 1	1	
E494	6780	256	26,5: 1	1½	
E495	10.845	208	52: 1	1½	

RIGID-BODY HYDRAULIC TORQUE WRENCHES



SQUARE DRIVE TORQUE WRENCHES

- Compact, high-strength uni-body construction with to small nose radius
- 35° rotation angle and rapid return stroke for fast operation
- Constant torque output provides accuracy of :1.3% across full stroke
- All X-Edition tools are CE-ATEX declared.

Model Number	Socket Size Range*		Square Drive (inch)	Max. Torque at 6911 bc (Nm)
	(inch)	(mm)		
S1500X	3/4-2	19-50	3/4	1952
S3000X	3/4-37/a	19-100	1	4373
S6000X	1 1/4-4%	36-115	1 1/2	8338
S11000X	1 1/4-4%	36-115	1 1/2	15.151
S25000X	2 1/4-6 1/4	65-155	2 1/2	34.099

\* See our BSH-Series heavy-duty sockets at [enerpac.com](http://enerpac.com)



LOW-PROFILE HEXAGON WRENCHES

- Superior strength to size ratio provides easy access difficult to reach applications
- Fast release drive unit enables rapid exchange of cassettes, no tools required
- Constant torque output provides accuracy of :1.3% across full stroke
- All X-Edition tools are CE-ATEX declared.

Drive Unit Model Nr.	Hexagon Cassette Range		Maximum Torque at 690 bar (Nm)
	(inch)	(mm)	
W2000X	1 1/4-2 1/4	24-60	2766
W4000X	1 1/2-3%	36-85	5661
W8000X	1 1/2-4 1/4	50-105	11.484
W15000X	2 1/2-4%	65-115	20.785
W22000X	2 1/2-5%	75-135	30.506
W35000X	3 1/4-6 1/4	80-155	47.454

Torque Calculation Engine

Enerpac's Bolting Calculator is our free web-based calculator designed to technically support our products. The software will calculate as well as recommend bolt load/stresses for your bolted applications.

You may choose between torque or tension as your tightening method and all calculations include hydraulic tool pressures based on tool selection.

- Calculation Features  
ANSI B16.5 & B16.47 Flanges  
API 6A & 17D Flanges  
Custom Calculations

ULTRA-SLIM TORQUE WRENCHES



PTW-SERIES, PNEUMATIC TORQUE WRENCHES

- High speed continuous rotation for constant torque output
- Ergonomic, low vibration design reduces fatigue and the risk of vibration related injuries for the operator
- Provided with standard reaction arm; wide assortment of custom arms and accessories are available.

Model Number*	Maximum Torque (Nm)	Square Drive (inch)	Speed (RPM)
PTW1000C	1356	1	12,6
PTW2000C	2712	1	8,0
PTW3000C	4067	1	3,1
PTW6000C	8135	1 1/2	2,5

\* (FRL and air hose included). To order without FRL and air hose, remove "C" suffix (example: PTW3000).



W-SERIES, ULTRASLIM BI-HEXAGONAL CASSETTES

- Lean, stepped width design allows tool to be mounted over bolts where other tools won't fit
- Premium components provide best-in-class endurance compared to other limited access tools
- Uses same drive unit as standard cassettes.

UltraSlim Cassette Model Nr.	Hexagon Size		Maximum Torque at 69D bar (Nm)
	(inch)	(mm)	
W2113SL	1 1/8	46	2712
W2203SL	23/16	55	2712
W2206SL	2%	60	2712
W4203SL	23/16	55	5830
W4206SL	2%	60	5830
W4209SL	2 1/16	65	5830
W4212SL	2 1/4	70	5830
W4215SL	2 1/2	75	5830



GT-SERIES, HYDRAULIC BOLT TENSIONERS

- Maximum operating pressure: 1500 bar
- Twin ports for quick connection of multiple tools
- For available adapter kits and additional technical details visit [www.enerpac.com](http://www.enerpac.com)

Load Cell and Bridge Reference	Threaded Fastener Range		Cylinder Effective Area (mm²)	Max. Load Capacity (kN)
	(inch)	(mm)		
GT1-LCB	1/2-1	M16-M30	1495,4	224,3
GT2-LCB	1 1/2-1 1/2	M30-M39	2677,2	401,5
GT3-LCB	1 1/2-2	M39-M52	5127,1	768,9
GT4-LCB	2-2 1/2	M52-M68	9782,1	1466,9
GT5-LCB	2 1/2-3 1/4	M68-M80	15079,7	2261,4
GT6-LCB	3 1/4-3 3/4	M80-M95	18972,1	2845,1





### Enerpac Bolting Service

- On-site demonstrations of Enerpac bolting tools
- Repair and calibration services
- Training for the safe and efficient use of Enerpac bolting tools

Offering full bolting tool service and maintenance wherever you need it.

We provide you with personalized bolting demonstrations and training, and the bolting service vehicle is equipped to perform torque wrench and other equipment calibrations and repairs on site.

We can give you advice on the best solutions and the bolting tools that are most suited to your application, thus enabling safe and controlled performance of your bolting activities.



#### ZU4T-SERIES, ELECTRIC WRENCH PUMPS

- Powerful universal motor draws lower amps for superior performance in remote locations
- Two-speed operation and high by-pass pressure reduces cycle time for improved productivity
- Composite shroud with integrated carrying handle for easy transportation

#### ZA4T-SERIES, AIR DRIVEN WRENCH PUMP

- Two-speed operation and high by-pass pressure reduces cycle time for improved productivity
- Heat exchanger cools oil and warms exhaust air to prevent freezing.

Model Number*	Max. Pressure (bar)	Useable Oil Capacity (litres)	Motor Voltage (VAC)	Air Pressure (bar)
ZU4204BE-QH	700	4,0	230	-
ZU4208BE-QH	700	8,0	230	-
ZA4204TX-Q	700	2,7	-	4,0 - 6,9
ZA4208TX-Q	700	6,6	-	4,0 - 6,9

\* ZU4T: 1,25 kW universal motor, 230 V-1 phase.  
ZA4T: Air consumption 600 - 2840 l/min.



#### TO-SERIES, ELECTRIC WRENCH PUMPS

- Optimized flow technology delivers up to 50% faster bolting than competing pumps
- Compact and lightweight design fits through tight openings and provides easy handling
- Built-in protection for controls and gauge for job-site durability
- IP55 rating for superior dust and water protection.

Model Number	Max. Pressure (bar)	Useable Oil Capacity (litres)	Motor Voltage (V-Ph-Hz)	Motor Power (kW)
TQ-700B	700	4,0	115-1-50/60	0,75
TQ-700E	700	4,0	230-1-50	0,75
TQ-700I	700	4,0	230-1-60	0,75



#### PMU-SERIES, PORTABLE ELECTRIC WRENCH PUMP

- Powerful two-speed pump is lightweight and easy to carry
- Standard heat exchanger package keeps pump cool under extreme use
- 0,37 kW universal motor for a high power-to-weight ratio; generates full pressure on as little as 50% of the rated line voltage.

Model Number	Max. Pressure (bar)	Useable Oil Capacity (litres)	Motor Voltage (V-Ph-Hz)
PMU-10427-Q	700	1,9	115-1-50/60
PMU-10447-Q	700	3,8	115-1-50/60
PMU-10422-Q	700	1,9	230-1-50/60
PMU-10442-Q	700	3,8	230-1-50/60



#### ZUTP-SERIES, ELECTRIC TENSIONER PUMP

- 1,25 kW universal motor draws lower amps for superior performance in remote locations
- Panel mounted 153 mm pressure gauge, with polycarbonate cover for improved visibility and safety

#### ATP-SERIES, AIR DRIVEN TENSIONER PUMP

- Compact, lightweight, rugged steel frame for protection and easy handling
- ATEX declared.

Model Number	Max. Pressure (bar)	Useable Oil Capacity (litres)	Motor Voltage (VAC)	Air Pressure (bar)
ZUTP-1500B	1500	4,0	115	-
ZUTP-1500E	1500	4,0	230	-
ATP-1500 *	1500	3,8	-	5,5 - 6,2

\* ATP air consumption 594 l/min.

## Integrated Solutions Heavy Lifting

Enerpac's Integrated Solutions provide hydraulic system solutions to meet customer requirements for safe, precise control of movement and positioning.

With more than 50 years of experience, Enerpac has gained unique expertise in delivering hydraulic solutions for the controlled movement and positioning of structures.



SL, SBL, MBL-SERIES, HYDRAULIC GANTRIES Heavy lifting systems that offer control and stability, even in confined spaces. For your most demanding lifting and rigging operations,



HSL-SERIES, STRAND JACKS Compact high capacity system for controlled lifting and lowering. Strand jack systems that provide fully controlled precise lifting.

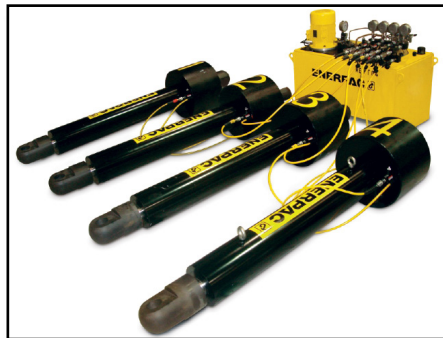

SHS-SERIES, SYNCHOIST - HIGH PRECISION LOAD POSITIONING SYSTEMS Accurate hoisting and load positioning system to enhance a crane's capability.

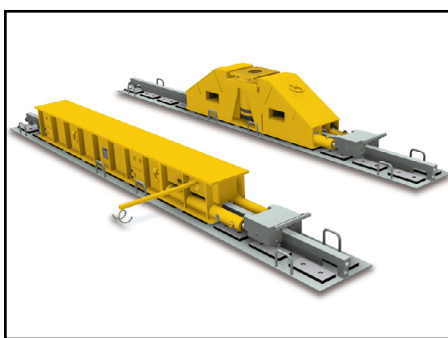

HSK, HSKLH-SERIES, SKIDDING SYSTEMS A system comprised of a series of skid-shoes powered by hydraulic push-pull cylinders, traveling over a pre-constructed track.



SPMT-SERIES, SELF-PROPELLED MODULAR TRAILERS A trailer with a slim design to transport large and heavy objects. Hydraulic strength in a linear drive transport system.



BLS-SERIES, STAGE LIFT CYLINDERS Double-acting cylinders with solid plunger design allow for a load to be lifted many times the stroke of the cylinder. The solution for incremental lifting.



SFP-SERIES, SPLIT FLOW PUMPS The split flow pump is an economical solution for multi-point controlled lifting applications. Multiple outlets with equal oil flow.



EVO-SERIES, SYNCHRONOUS LIFTING SYSTEMS High-pressure hydraulics combined with PLC-controlled monitoring systems for precise lifting applications. The multi-functional lifting system.

### Slogging Hammer - Standard Open Air

(Aluminium Tube, Nylon Nut with Steel Impact Head)

	Configuration	Product Code	BMG Code	Product Description
	C1-2	SH-SO-1-2	A0012348	Standard Open Air-Configuration 1-2
	C3	SH-SO-3	A0012351	Standard Open Air-Configuration 3
	C3.5	SH-SO-3.5	A0016429	Standard Open Air-Configuration 3.5
	C4	SH-SO-4	A0012353	Standard Open Air-Configuration 4

**NOTE:** To be used in environments where spark is permitted: Mining (excluding coal mining underground), Farming, Construction, Power Stations and Automotive

### Slogging Hammer - Standard Spark Free Open Air

(Aluminium Tube, Nylon Nut with Copper Impact Head)

	Configuration	Product Code	BMG Code	Product Description
	C1-2	SH-SSFO-1-2	On Request	Standard Spark Free Open Air-Configuration 1-2
	C3	SH-SSFO-3	On Request	Standard Spark Free Open Air-Configuration 3
	C3.5	SH-SSFO-3.5	On Request	Standard Spark Free Open Air-Configuration 3.5

**NOTE:** To be used in environments where spark is not permitted: Mining (excluding coal mining underground), Farming, Construction, Power Stations, Automotive and Petrochemical

### Slogging Hammer - Underground

(Stainless Steel Tube, Nylon Nut with Steel Impact Head)

	Configuration	Product Code	BMG Code	Product Description
	C1-2	SH-UG-1-2	On Request	Underground Configuration 1-2
	C3	SH-UG-3	A0037635	Underground Configuration 3
	C3.5	SH-UG-3.5	On Request	Underground Configuration 3.5

**NOTE:** To be used in environments where spark is permitted: Mining, Farming, Construction, Power Stations and Automotive

### Slogging Hammer - Underground Spark Free

(Aluminium Tube, Nylon Nut with Steel Copper Head)

	Configuration	Product Code	BMG Code	Product Description
	C1-2	SH-UGSF-1	On Request	Underground Spark Free Configuration 1-2
	C3	SH-UGSF-2	On Request	Underground Spark Free Configuration 3
	C3.5	SH-UGSF-3	On Request	Underground Spark Free Configuration 3.5

**NOTE:** To be used in environments where spark is not permitted: Mining, Farming, Construction, Power Stations, Automotive and Petrochemical

### Slogging Hammer - Carry Bag

	Configuration	Product Code	BMG Code	Product Description
	C1-2	SH-CB-1-2	A0012361	Carry Bag
	C3	SH-CB-3	A0012361	Carry Bag
	C3.5	SH-CB-3.5	On Request	Carry Bag - Config 3.5

**NOTE:** C1-2 and C3 fits in the same carry bag. C3.5 requires a larger size carry bag. C4 carry bags are not available.

### Slogging Hammer - Socket Adaptor

	Configuration	Product Code	BMG Code	Product Description
	C1-2, C3, C3.5	SSPAN-ADAP	A0012405	Socket Adaptor - 3/4" Drive & 1" Drive

**NOTE:** C1-2, C3 and C3.5 can be used with the socket adaptor. C4 is not recommended due to the impact exerted.

### Slogging Hammer - Tyre Chisel "Bead Breaker"

	Configuration	Product Code	BMG Code	Product Description
	C1-2, C3, C3.5	SH-TYRE CHISEL	A0012434	Slogging Hammer Bead Breaker

**NOTE:** C1-2, C3 and C3.5 can be used with the bead breaker. C4 is not recommended due to the impact exerted.

### Slogging Hammer - Pin Extractor

	Configuration	Product Code	BMG Code	Product Description
	C3, C3.5, C4	SH-EXTRAC-PIN	A0012434	Slogging Hammer Pin Extractor

**NOTE:** C3, C3.5 and C4 can be used with the pin extractor. Please enquire on the different pin lengths.

### Slogging Hammer - Coal Pick Chisel

	Configuration	Product Code	BMG Code	Product Description
	C1-2, C3, C3.5	SH-CPICK-CHISEL	A0012347	Slogging Hammer Coal Pick Chisel

**NOTE:** C1-2, C3 and C3.5 can be used with the coal pick chisel. C4 is not recommended due to the impact exerted.

### Slogging Hammer - Bobbins

	Configuration	Product Code	BMG Code	Product Description
	C1-2, C3, C3.5	SH-BOBBIN-4 PACK	A0012365	Slogging Hammer Bobbin - 4 Pack
	C1-2, C3, C3.5	SH-BOBBIN-12 PACK	A0012366	Slogging Hammer Bobbin - 12 Pack
	C4	SH-BOBBIN-C4	On Request	Slogging Hammer Bobbin - Config 4

**NOTE:** C1-2 and C3 fits the same bobbin. C4 requires a larger ID in the same bobbin.

### Slogging Hammer - Socket Adaptor

	Configuration	Product Code	BMG Code	Product Description
	C1-2, C3, C3.5	SSPAN-ADAP	A0012405	Socket Adaptor - 3/4" Drive & 1" Drive

**NOTE:** C1-2, C3 and C3.5 can be used with the socket adaptor. C4 is not recommended due to the impact exerted.

### Slogging Hammer - Tyre Chisel "Bead Breaker"

	Configuration	Product Code	BMG Code	Product Description
	C1-2, C3, C3.5	SH-TYRE CHISEL	A0012434	Slogging Hammer Bead Breaker

**NOTE:** C1-2, C3 and C3.5 can be used with the bead breaker. C4 is not recommended due to the impact exerted.

### Slogging Hammer - Pin Extractor

	Configuration	Product Code	BMG Code	Product Description
	C3, C3.5, C4	SH-EXTRAC-PIN	A0012434	Slogging Hammer Pin Extractor

**NOTE:** C3, C3.5 and C4 can be used with the pin extractor. Please enquire on the different pin lengths.

### Slogging Hammer - Coal Pick Chisel

	Configuration	Product Code	BMG Code	Product Description
	C1-2, C3, C3.5	SH-CPICK-CHISEL	A0012347	Slogging Hammer Coal Pick Chisel

**NOTE:** C1-2, C3 and C3.5 can be used with the coal pick chisel. C4 is not recommended due to the impact exerted.

### Slogging Hammer - Bobbins

	Configuration	Product Code	BMG Code	Product Description
	C1-2, C3, C3.5	SH-BOBBIN-4 PACK	A0012365	Slogging Hammer Bobbin - 4 Pack
	C1-2, C3, C3.5	SH-BOBBIN-12 PACK	A0012366	Slogging Hammer Bobbin - 12 Pack
	C4	SH-BOBBIN-C4	On Request	Slogging Hammer Bobbin - Config 4

**NOTE:** C1-2 and C3 fits the same bobbin. C4 requires a larger ID in the same bobbin.

### Slogging Hammer - Retaining Rings

	Configuration	Product Code	BMG Code	Product Description
	C1-2, C3, C3.5, C4	SH-RRING	A0012367	Retaining Ring - 16 Pack

**NOTE:** C1-2, C3, C3.5 and C4 all use the same retaining ring.

### Slogging Hammer - Retaining Pins

	Configuration	Product Code	BMG Code	Product Description
	C1-2, C3, C3.5, C4	SH-RRING	A0012349	Slogging Hammer Retaining Pin
	C4	SH-PIN-C4	On Request	Slogging Hammer Retaining Pin - C4

**NOTE:** C1-2, C3 and C3.5 uses the same pin. C4 Requires a larger size pin.

### Slogging Hammer - Locking Clip

	Configuration	Product Code	BMG Code	Product Description
	C1-2, C3, C3.5	SH-LCLIP	On Request	Locking Clip - 4 Pack

**NOTE:** C1-2, C3 and C3.5 all use the same locking clip. C4 is not available.

### Slogging Hammer - Impact Head

	Impact Head	Configuration	Barrel Type	Product Code	BMG Code
	Steel	C1-2, C3, C3.5	Aluminium	A0012375	MD-SG0080
	Steel	C4	Aluminium	A0012376	MD-SG0081
	Copper	C1-2, C3, C3.5	Aluminium	A0012401	MD-SG-0132
	Steel	C1-2, C3, C3.5	Stainless Steel	A0012398	MD-SG0127
	Copper	C1-2, C3, C3.5	Stainless Steel	A0012404	MD-SG0137

**NOTE:** Please choose the correct barrel type and configuration together with your choice of impact head.



CHOOSING THE CORRECT SLOGGING HAMMER CONFIGURATION - METRIC (mm)

Choosing the Correct Slogging Hammer Configuration - Metric (mm)								
<i>(recommended, but May Vary per Application)</i>								
BMG Part Code	Product Code	Metric Thread Size	Slogging Spanner A/f Size (mm)	Product Description	Config 1-2	Config 3	Config 3.5	Config 4
A0012406	SH-SSPAN-24	M16	24	Slogging Spanner 24mm A/F	X			
A0012407	SH-SSPAN-27	M18	27	Slogging Spanner 27mm A/F	X			
A0012408	SH-SSPAN-30	M20	30	Slogging Spanner 30mm A/F	X			
A0012409	SH-SSPAN-32	M22	32	Slogging Spanner 32mm A/F	X			
A0012410	SH-SSPAN-34	—	34	Slogging Spanner 34mm A/F	X			
A0012411	SH-SSPAN-36	M24	36	Slogging Spanner 36mm A/F	X			
A0012413	SH-SSPAN-38	—	38	Slogging Spanner 38mm A/F	X	X		
A0012414	SH-SSPAN-41	M27	41	Slogging Spanner 41mm A/F		X	X	
A0012416	SH-SSPAN-46	M30	46	Slogging Spanner 46mm A/F		X	X	
A0012417	SH-SSPAN-50	M33	50	Slogging Spanner 50mm A/F		X	X	
A0012419	SH-SSPAN-55	M36	55	Slogging Spanner 55mm A/F		X	X	
A0012420	SH-SSPAN-60	M39	60	Slogging Spanner 60mm A/F		X	X	
A0012421	SH-SSPAN-65	M42	65	Slogging Spanner 65mm A/F		X	X	
A0012422	SH-SSPAN-70	M45	70	Slogging Spanner 70mm A/F			X	
A0012423	SH-SSPAN-75	M48	75	Slogging Spanner 75mm A/F			X	
A0012424	SH-SSPAN-80	M52	80	Slogging Spanner 80mm A/F			X	X
A0012425	SH-SSPAN-85	M56	85	Slogging Spanner 85mm A/F				X
A0012426	SH-SSPAN-90	M60	90	Slogging Spanner 90mm A/F				X
A0012427	SH-SSPAN-95	M64	95	Slogging Spanner 95mm A/F				X
A0012430	SH-SSPAN-100	M68	100	Slogging Spanner 100mm A/F				X
A0012428	SH-SSPAN-105	M72	105	Slogging Spanner 105mm A/F				X
A0012429	SH-SSPAN-110	M76	110	Slogging Spanner 110mm A/F				X

This product includes a drilled hole

### Slogging Hammer Freight Information

Product Code	BMG Code	Unit Net Weight (Kg)	Unit Gross Weight (Kg)	Packaging Size (mm)
SH-SO-1-2	A0012347	5.45	6.25	660*165*105
SH-SO-3	A0012351	6.75	7.55	660*165*105
SH-SO-3.5	A0016429	9.20	10.20	860*165*105
SH-SO-4	A0012353	21.70	21.10	1140*180*130
SH-UG-1-2	A0012347	5.90	6.80	660*165*105
SH-UG-3	A0012351	7.20	8.10	660*165*105
SH-UG-3.5	A0012347	9.60	10.60	660*165*105

**NOTE:** The weight difference between Steel impact heads and Copper impact heads are minimum. Use weights as indicated above

## Wheel Slogger

### Slogging Hammer - Socket Adaptor

	Configuration	Product Code	BMG Code	Product Description
	C1-2, C3, C3.5	SSPAN-ADAP	A0012405	Socket Adaptor-3/4" Drive & 1" Drive

**NOTE:** C3 and C3.5 Can be used with the socket adaptor.

### Slogging Hammer - Tyre Chisel "Bead Breaker"

	Configuration	Product Code	BMG Code	Product Description
	C1-2, C3, C3.5	SH-TYRE CHISEL	A0012367	Slogging Hammer Bead Breaker

**NOTE:** C3 and C3.5 can be used with the bead breaker.

### Slogging Hammer - Bobbins

	Configuration	Product Code	BMG Code	Product Description
	C1-2, C3, C3.5	SH-BOBBIN-4 PACK	A0012365	Slogging Hammer Bobbin-4 Pack
	C1-2, C3, C3.5	SH-BOBBIN-12 PACK	A0012365	Slogging Hammer Bobbin-4 Pack

**NOTE:** C3 and C3.5 fits the same bobbin.



### Slogging Hammer - Retaining Ring

	Configuration	Product Code	BMG Code	Product Description
	C3, C3.5	SH-RRING	A0012367	Retaining Ring - 16 Pack

NOTE: C3, C3.5 all use the same retaining ring.

### Slogging Hammer - Retaining Pin

	Configuration	Product Code	BMG Code	Product Description
	C1-2, C3, C3.5	SH-PIN-C1-2.3.3.5	A0012349	Slogging Hammer Coal Retaining Pin

NOTE: C3 and C3.5 use the same size pin.

### Slogging Hammer - Locking Clip

	Configuration	Product Code	BMG Code	Product Description
	C1-2, C3, C3.5	SH-LCLIP	On Request	Slogging Hammer Locking Clip-4 Pack

NOTE: C3 and C3.5 all use the same locking Clip .

### Slogging Hammer - Impact Head

	IMPACT HEAD	Configuration	Barrel Type	Product Code	BMG Code
	Steel	C1-2, C3, C3.5	Aluminium	SH-IHS-SO-3	A0012375
	Copper	C1-2, C3, C3.5	Aluminium	SH-IHC-SSO-3	A0012401

NOTE: C3 and C3.5 Can be used with the socket adaptor.

### Slogging Hammer - Torque Clips

	Configuration	Product Code	BMG Code	Product Description
	TE, CE, ME	WS-TCLIP-1 SET	A0012380	Wheel Slogger TCLIP -4 Pack (1 Set) "450Nm, 550Nm, 600Nm, 650Nm"

NOTE: Can be sold separately.

Wheel Slogger - Freight Information

Product code	BMG Code	Unit Net Weight (kg)	Unit Gross Weight (Kg)	Packaging Size (mm)
WS-TE-01	MD-SG0020	30.60	33.00	950 x 370 x 285
Includes				
SH-SO-3	A0012351	6.75		
WS-TE STAND	A0012354	17.00		
WS-TOOLBOX	On Request	6.85		
TE, CE, ME	On Request	MD-SG0162		

WS-CE-01	MD-SG0025	31.8	34.20	950 x 370 x 285
Includes				
SH-SO-3	A0012351	6.75		
WS-CE STAND	A0012356	18.2		
WS-TOOLBOX	On Request	6.85		

WS-ME-01	MD-SG0027	31.60	34.20	950 x 370 x 285
Includes				
SH-SO-3	A0012351	6.75		
WS-TE STAND	A0012358	18.2		
WS-TOOLBOX	On Request	6.85		





## Mounting Tool Kit Case

WORKSHOP EQUIPMENT



The NTN-SNR tool kit enables for quick and accurate mounting of bearings in complete safety.

### Applications

The right combination of impact ring and mounting sleeve ensures the effective transmission of mounting force.

The simultaneous support of the outer and inner rings prevents the risk of deterioration of the races and rotating assemblies.

The kit can also be used for assembling other components such as sealing rings, pinions and pulleys.

### Advantages

Light and strong construction for workshop use, this toolbox contains:

*33 impact rings:*

- Very robust for a long working life
- Impact-resistant, synthetic material, avoiding any metal-to-metal contact
- Ideal for use in conjunction with a press
- Calibrated for approximately 400 different bearings
  - with bore diameters between 10 and 50 mm
  - and with outside diameters between 26 and 110 mm
- Clearly and permanently identified to aid selection

*3 mounting sleeves:*

- Light and extremely robust, made of aluminium
- With a good grip for the hand

*1 special dead blow mallet, ensuring optimum impact force is applied.*

### Part Number

IMPACT FIT/TOOL

### Description

Industry Fitting Tool Set

WORKSHOP EQUIPMENT

Bore Puller



BP SET 35-100



BP SET 12-45

Puller kits for internal gripping of the bore.  
For quick and easy dismounting of bearings tightly mounted in a housing.

**Applications**  
Ideal selection of high-strength extractors with braces for extraction via the bore:  
- Bearing whose outer ring is a tight fit in its housing.

**Advantages**

*Robust*

- Pullers designed in 2 parts and manufactured in special, strong, break and wear-resistant steel, ensuring a long life.
- Arms in carbon nitride steel (not requiring any special maintenance)

*Ergonomic*

- Mechanical spindle with handle

*Wide range of use*

- BP Set 12-45 includes 6 pullers for 12 to 45 mm bore diameters
- BP Set 35-100 includes 4 pullers for 35 to 100 mm bore diameters

Each kit is supplied in a solid steel case.

**Part Number**  
TOOL BPSET 5-44  
TOOL BPSET 45-100

**Description**  
Bore Puller

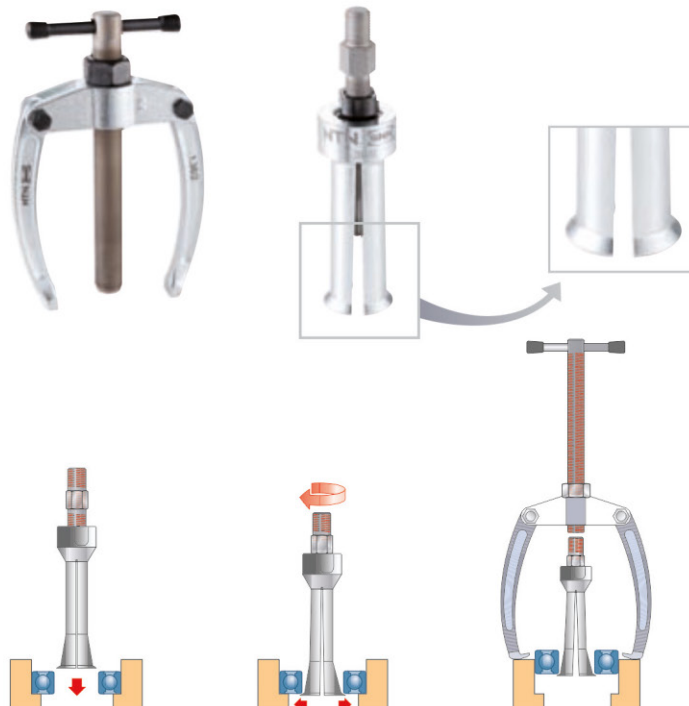



## Puller-Separator with Mechanical Spindle

For an easy and safe dismounting of rings or bearings tightly fitted on a shaft



### Applications

Allows the extraction of all parts mounted onto a shaft by force, such as pulleys, hand wheels and pinions.

The set, supplied in a strong steel case, includes:

- a puller/pusher with 5 ton capacity mechanical spindle.
- extension rods for quick adaptation to required pulling length.
- a 2-blade separator to separate and grip rings and bearings from the rear with an external dimension between 22 and 115 mm.

### Advantages

*Practical and Safe*

- Gradual simple screw extraction
- The sharp bevelled blades ensure a good grip, so avoiding any locking of the part to be extracted and any deterioration of the shaft's seat.
- After separation by tightening the two blades, turning the separator enables greater force to be used without deforming the blades for the complete extraction of the part

*Robust*

- Separating blades are made of special steel for added strength and durability.
- The arm in carbon nitride steel does not require any special maintenance; no more need for oil or grease

### Part Number

TOOL BPES 10-1 OS

### Description

Back Puller Mech Spindle

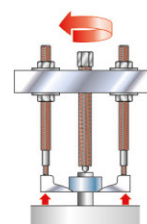
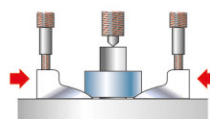
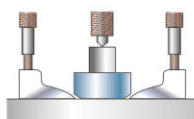

## 2/3 Arm Self-centering Hydraulic Puller (SCHP)



A range of powerful pullers for safe and easy dismantling of large bearings and force-fitted parts such as pulleys and gear wheels.

### Applications

The self-centering device facilitates positioning and anchoring around the bearing. The power developed by the hydraulic system allows the part to be extracted safely with very little effort.

### Advantages

#### Practical and Safe

- Ready-to-use in a strong case. No assembly of the jaws required before use.
- Compact: the self contained hydraulic pump and cylinder save space. No need for a separate pump, hose or spindle.
- Ergonomic: pump handle pivoting through 360°, allowing the extractor to be used in the most comfortable position. Telescopic, it provides optimum transmission of the effort.
- Easy centering of the piston on the shaft with retractable, integrated point.
- A piston extension is supplied for use with a remote support surface.
- A piston return device makes it ready immediately for further use.
- The long stroke of hydraulic spindle facilitates dismantling in one operation.

#### Robust

- Possibility to change between two or three jaws, depending on the accessibility of the bearing.
- Available in three versions, depending on the power and size required: 4, 12, 20 and 30 tons.



SCHP 4T - 3 arms



SCHP 4T - 2 arms

Capacity tons	Max. spread mm	Max. reach mm	Cylinder stroke mm
4*	325	190	60
12*	485	305	85
20*	570	365	111
30**	680	465	111

\*\*30 tons: Available on special order only.

\*All pullers may be subject to an 8 week lead time.

- For the 4 and 12-ton capacity, an accessory kit consisting of a puller block, connecting rods and a set of bearings separators increases the number of uses and makes separation easier.

#### Safe

- A safety relief valve prevents any risk of overloading and limits the force applied to the maximum capacity of the equipment.
- A cover protects the user from possible flying bearing fragments. Made of transparent material, it provides good visibility for controlling the extraction.
- The 20-ton model is equipped with an innovative two-stage pump which makes operation easier and safer.

### Part Number

TOOL SCHP 4 T (4 TONS)  
TOOL SCHP 12 T (12 TONS)  
TOOL SCHP 20 T (20 TONS)  
TOOL SCHP 30 T (30 TONS)

### Description

Self-center Hydraulic Puller





## Accessory Case for 4 & 12 Ton SCHP



A strong grip for safe and easy dismounting.

### Applications

A separator is a complementary tool to a claw extractor when the latter does not have sufficient grip. A perfect grip on the back of parts, using bevelled blades, reduces the force necessary for dismounting and avoids damaging the shaft's contact surface.

### Advantages

- Robust design ensuring a long life for the separation blades.
- After separation by tightening the two blades, turning the separator enables greater force to be used without deforming the blades for the complete extraction of the part.
- Easy centering of the piston on the shaft with its retractable, integrated point.
- Two versions are available, depending on the power required. 4 and 12 tons.

### Part Number

TOOLAS-SCHP 4T (4 TONS)  
TOOLAS-SCHP 12T (12 TONS)

### Description

Accessory Set Hydraulic Puller

## Tri-section Pulling Plate, Universal



A strong grip for safe and effective dismounting using a mechanical or hydraulic extractor.

### Applications

The tri-section pulling plate is the complementary tool to the three-armed pullers when the latter does not have sufficient grip. Universal, it is suitable for all NTN-SNR SCHP hydraulic extractors.

### Advantages

- The blades fix behind the bearing's inner ring, where the extraction force is most effective.
- The application of the effort on the inner ring minimises the risk of damaging the bearing while preserving the rolling body and the outer ring.
- The tri-section construction distributes the extraction force evenly, preventing bearing from locking and/or tilting on the shaft during dismounting.

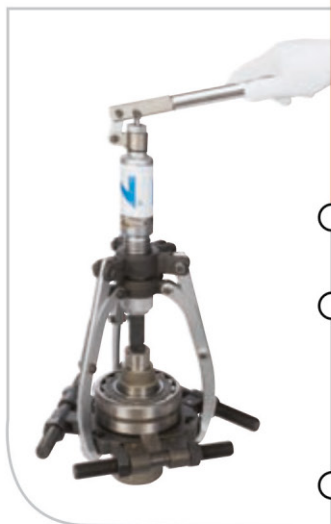

	BP3S 26-160	BPS3 50-210	BPS3 90-340	BPS3 14-395
Shaft Diameter	26-160mm	50-210mm	90-340mm	140-495mm
Capacity	4 Tons	8 Tons	12 Tons	30 Tons

### Part Number

TOOL BP3S 26-160  
TOOL BP3S 50-210  
TOOL BP3S 90-340  
TOOL BP3S 140-495

### Description

Tri-section Back Puller

All accessories may be subject to an 8 week lead time.

BBPS 10-100



A new deep groove ball bearing puller set from NTN-SNR for pulling from blind housings.

**Features**

*Time saving.* Easy and quick extraction of your bearing thanks to the O-rings and the selection chart included.

*Adaptability.* 3 Sizes puller of arms to dismount a wide range of bearings internal 0 from 5 to 100 mm.

*Reliable. Effortless.* The perfect tool to securely remove the bearing without dismantling the engine.

**Kit Contents**

- 3 x Spindles
- 3 x O-rings
- 28 x Puller arms
- 22 x Metal Rings Marked
- 1 x Handle
- 1 x Tapered Interlock

**Selection Chart**

	Extractors		
	BBPS A	BBPS B	BBPS C
To be used with the following bearings	6000 to 6006 6200 to 6205 6300 to 6303 16002 to 16101 62/22	6007 to 6012 6206 to 6207 6304 to 6306 16011 62/28	6014 to 6020 6208 to 6213 6307 to 6311 6403 to 6406 63/28



**Part Number**

TOOL BBPS 10-100

**Description**

Ball Bearing Puller Set





**Features:**

- **Fast, Uniform Heating**  
Induction heating reduces mounting time and cost.
- **No Oil Tanks Required**  
Since no oil is necessary, there can be no spills or other mess and bearings remain clean.
- **Safe Operation**  
Since there are no flames, there are no fire hazards and an internal circuit breaker guards against an electrical short.
- **Compact and Light**  
Most bearing heaters are light enough to be carried easily and used any where (with trolleys on Models 030, 040 & 050)
- **Automatic Temperature Control**  
A thermostatic control can be set at any temperature up to 130°C and a constant temperature is maintained.
- **Automatic Demagnetizing**  
When the heating is finished, the bearing is quickly and automatically demagnetized.

- **Electronic Control**  
Soft start and current limiter.
- **Versatility**  
Besides bearings, other metallic rings such as inner ring spacers can also be heated for shrink fitting or for other purposes.

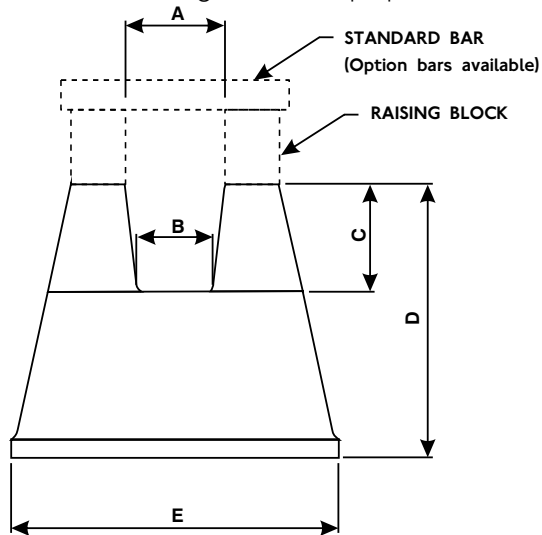

Dimensions	Model 020	Model 030	Model 040	Model 050
A - Distance between supports (top)	105 mm	185mm	210mm	285mm
B - Distance between supports (bottom)	95 mm	135 mm	200 mm	215 mm
C - Height of supports	110 mm	170 mm	180 mm	240 mm
D - Total heights	275 mm	330 mm	340 mm	445 mm
E - Width	330 mm	480 mm	520 mm	680 mm
Weight of heater	29 kg	56 kg	27 kg	104 kg
Weight of trolley	N/A	23 kg	8 kg	35 kg

### Model 020 (Small Heater)

- Operating Voltage - 220 Volts
- Frequency - 50Hz
- Power Consumption - 10 Amps max
- Bearing Bore Size - 25 mm upwards

**Standard Bar Sizes**

Dimensions	Min Bearing ID
- (1) 15 x 15 x 230 mm	22 mm
- (2) 40 x 40 x 230 mm	58 mm
- (3) 57 x 57 x 230 mm	82 mm

**Optional Bar Sizes**

Dimensions	Min Bearing ID
- (1) 25 x 25 x 230 mm	37 mm
- (2) 35 x 35 x 230 mm	51 mm
- (3) 42 x 42 x 230 mm	60 mm

- Raising Blocks - (1) 55 x 55 x 75 mm high (Optional)



### Model 030 (Medium Heater)

Operating Voltage - 220 Volts  
 Frequency - 50Hz  
 Power Consumption - 20 Amps max  
 Bearing Bore Size - 60 mm Upwards  
 Standard Bar Sizes

<u>Dimensions</u>	<u>Min bearing ID</u>
- (1) 42 x 42 x 340 mm	60 mm
- (2) 70 x 70 x 340 mm	100 mm

Optional Bar Sizes

<u>Dimensions</u>	<u>Min bearing ID</u>
- (1) 15 x 15 x 340 mm	22 mm
- (2) 17 x 17 x 340 mm	25 mm
- (3) 20 x 20 x 340 mm	30 mm
- (4) 30 x 30 x 340 mm	44 mm

Raising Blocks - (1) 70 x 70 x 115 mm high  
 (Optional)



### Model 040 (Medium / Large Heater)

Operating Voltage - 220 Volts  
 Frequency - 50/60Hz  
 Power Consumption - 20 Amps max  
 Bearing Bore Size - 28mm Upwards  
 Standard Bar Sizes

<u>Dimensions</u>	<u>Min bearing ID</u>
- (1) 36 x 36 x 380 mm	50 mm
- (2) 60 x 60 x 380 mm	100 mm

Optional Bar Sizes

<u>Dimensions</u>	<u>Min bearing ID</u>
- (1) 25 x 25 x 380 mm	28 mm

Raising Blocks - (1) 60 x 60 x 60 mm high  
 (Optional)



### Model 050 (Large Heater)

Operating Voltage - 380 Volts  
 Frequency - 50Hz  
 Power Consumption - 30 Amps max  
 Bearing Bore Size - 80mm Upwards  
 Standard Bar Sizes

<u>Dimensions</u>	<u>Min bearing ID</u>
- (1) 56 x 56 x 480 mm	80 mm
- (2) 90 x 90 x 480 mm	130 mm

Optional Bar Sizes

<u>Dimensions</u>	<u>Min bearing ID</u>
- (1) 35 x 35 x 480 mm	51 mm
- (2) 70 x 70 x 480 mm	100 mm

Raising Blocks - (1) 90 x 90 x 150 mm high  
 (Optional)





The NTN-SNR toolkit enables for quick and accurate mounting in complete safety.



**Applications**

The right combination of impact ring and mounting sleeve ensures the effective mounting force. The simultaneous support of the outer and inner rings prevents the risk of deterioration of the races and rotating assemblies. The kit can also be used for assembling other components such as sealing rings, pinions and pulleys.

**Advantages**

Light and strong construction for workshop use, this toolbox contains:

33 *impact rings*:

- Very robust for a long working life
- Impact-resistant, synthetic material, avoiding any metal-to-metal contact
- Ideal for use in conjunction with a press
- Calibrated for approximately/ 400 different bearings
  - with bore diameters between 10 and 50 mm
  - and with outside diameters between 26 and 110 mm
- Clearly and permanently identified to aid selection

3 *mounting sleeves*:

- Light and extremely robust, made of aluminium
- With a good grip for the hand

1 *special dead-blow mallet, ensuring optimum impact force is applied.*

**Part Number**

TOOL IFT SET 33

**Description**

Industry Fitting Tool Set

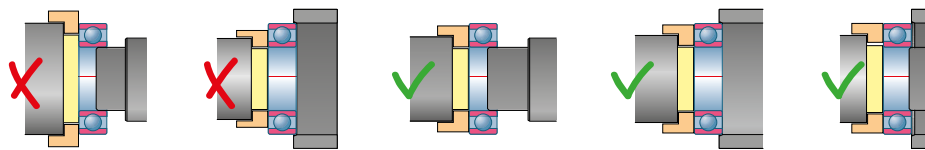

For Your Application, Select the Most Suitable Grease for Your Automatic Lubricator



**Applications**

The right combination of impact ring and mounting sleeve ensure the effective transmission of mounting force. The simultaneous support of the outer and inner rings prevents the risk of deterioration of the races and rotating assemblies. The kit can also be used for assembling other components such as sealing rings, pinions and pulleys.

**Advantages**

Light and strong construction for workshop use, this toolbox contains:

33 *impact rings*:

- Very robust for a long working life
- Impact-resistant, synthetic material, avoiding any metal-to-metal contact
- Ideal for use in conjunction with a press
- Calibrated for approximate~ 400 different bearings
  - with bore diameters between 10 and 50 mm
  - and with outside diameters between 26 and 110 mm
- Clearly and permanently identified to aid selection

3 *mounting sleeves*:

- Light and extremely robust, made of aluminium
- With a good grip for the hand

1 *special dead-blow mallet, ensuring optimum impact force is applied.*

**Part Number**

TOOL IFT SET 33

**Description**

Industry Fitting Tool Set

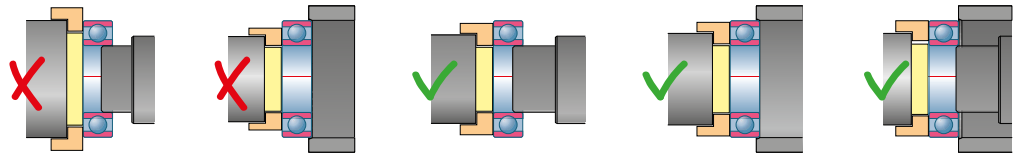



## A New Generation of the Electromechanical Single Point Lubricator System



### Applications

The right combination of impact ring and mounting sleeve ensures the effective transmission of mounting force. The simultaneous support of the outer and inner rings prevents the risk of deterioration of the races and rotating assemblies. The kit can also be used for assembling other components such as sealing rings, pinions and pulleys.

### Advantages

Light and strong construction for workshop use, this toolbox contains:

#### 33 impact rings:

- Very robust for a long working life
- Impact-resistant, synthetic material, avoiding any metal-to-metal contact
- Ideal for use in conjunction with a press
- Calibrated for approximately 400 different bearings
  - with bore diameters between 10 and 50 mm
  - and with outside diameters between 26 and 110 mm
- Clearly and permanently identified to aid selection

#### 3 mounting sleeves:

- Light and extremely robust, made of aluminium
- With a good grip for the hand

1 special dead-blow mallet, ensuring optimum impact force is applied.

### Part Number

TOOL IFT SET 33

### Description

Industry Fitting Tool Set

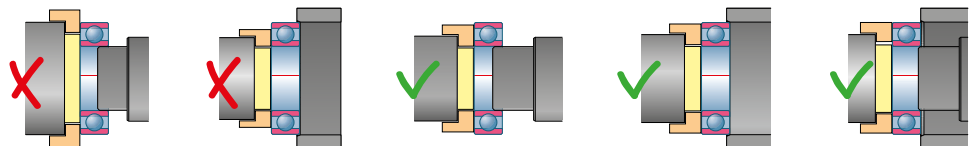

For Your Application, Select the Most Suitable Grease for Your Automatic Lubricator



**Applications**

The right combination of impact ring and mounting sleeve ensures the effective transmission of mounting force. The simultaneous support of the outer and inner rings prevents the risk of deterioration of the races and rotating assemblies. The kit can also be used for assembling other components such as sealing rings, pinions and pulleys.

**Advantages**

Light and strong construction for workshop use, this toolbox contains:

*33 impact rings:*

- Very robust for a long working life
- Impact-resistant, synthetic material, avoiding any metal-to-metal contact
- Ideal for use in conjunction with a press
- Calibrated for approximately 400 different bearings
  - with bore diameters between 10 and 50 mm
  - and with outside diameters between 26 and 110 mm
- Clearly and permanently identified to aid selection

*3 mounting sleeves:*

- Light and extremely robust, made of aluminium
- With a good grip for the hand

*1 special dead-blow mallet, ensuring optimum impact force is applied.*

**Part Number**

TOOL IFT SET 33

**Description**

Industry Fitting Tool Set

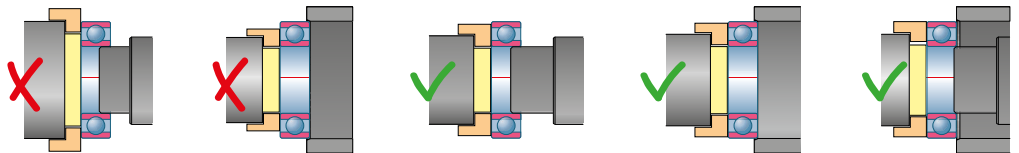



**Features:**

- Fast, uniform, induction heating reduces mounting time and cost.
- No Oil Tanks Required since no oil is necessary, there can be no spills or other mess and bearings remain clean.
- Safe Operation since there are no flames, there are no fire hazards and an internal circuit breaker guards against an electrical short.
- Compact and Light most bearing heaters are light enough to be carried easily and used any place (with trolleys on Models 030, 040 & 050)
- Automatic Temperature Control a thermostatic control can be set at any temperature up to 130°C and a constant temperature is maintained.
- Automatic Demagnetising when the heating is finished, the bearing is quickly and automatically demagnetised.
- Electronic Control, soft start and current limiter
- Versatility, besides bearings, other metallic rings such as inner ring spacers can also be heated for shrink fitting or for other purposes

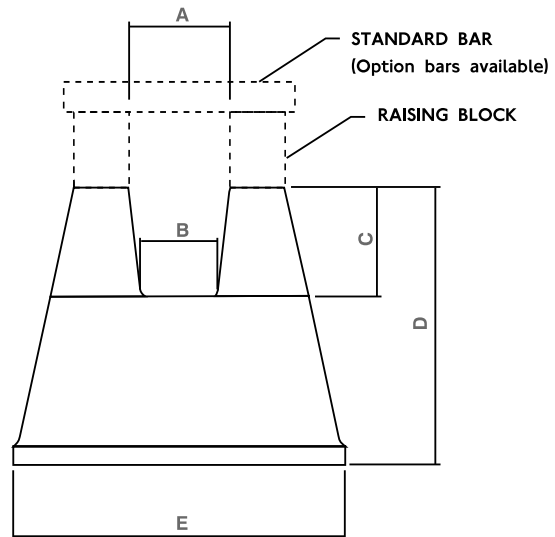

Dimensions	Model 020	Model 030	Model 040	Model 050
A - Distance between supports (top)	105 mm	185 mm	210 mm	285 mm
B - Distance between supports (bottom)	95 mm	135 mm	200 mm	215 mm
C - Height of supports	110 mm	170 mm	180 mm	240 mm
D - Total heights	275 mm	330 mm	340 mm	445 mm
E - Width	330 mm	480 mm	520 mm	680 mm
Weight of heater	29 kg	56 kg	27 kg	104 kg
Weight of trolley	N/A	23 kg	8 kg	35 kg

**Model 020 (Small Heater)**

Operating voltage - 220 Volts  
 Frequency - 50Hz  
 Power consumption - 10 Amps max  
 Bearing bore size - 25 mm upwards  
 Standard Bar Sizes

Dimensions	Min Bearing ID
- (1) 15 x 15 x 230 mm	22 mm
- (2) 40 x 40 x 230 mm	58 mm
- (3) 57 x 57 x 230 mm	82 mm

Optional Bar Sizes

Dimensions	Min Bearing ID
- (1) 25 x 25 x 230 mm	37 mm
- (2) 35 x 35 x 230 mm	51 mm
- (3) 42 x 42 x 230 mm	60 mm

Raising Blocks - (1) 55 x 55 x 75 mm high  
 (Optional)



Please contact the bearings division for more information